

TPM-01E, TPM-01ES and TPM-01ESH USER GUIDE



- * Measures up to voltage harmonics 31st. (TPM-01ES and TPM-01ESH)
- * Measures up to current harmonics 31st. (TPM-01ES and TPM-01ESH)
- * Supports 3P4W connections.
- * RS485 Modbus RTU (TPM-01ES and TPM-01ESH)
- * 4x4 Digit LED Display.
- * It shows the powers of each phase (P1, P2, P3).
- * It shows the reactive powers of each phase (Q1, Q2, Q3 inductive and capacitive).
- * It shows the apparent powers of each phase (S1, S2, S3).
- * It shows power factors (PF) and $\cos\phi$ values of each phases.
- * It shows the min., max. and ave. values of the phase-to-phase and phase-neutral voltages.
- * It shows the values of each phase (I1, I2, I3).
- * It shows total import and export active (ΣkWh) energy.
- * It shows total inductive and capacitive reactive ($\Sigma kVarh$) energy.
- * Digital Input. (TPM-01ESH)
- * Relay output (adjustable). (TPM-01ES and TPM-01ESH)
- * It shows voltage and current unbalance. (TPM-01ES and TPM-01ESH)
- * It show demands. (TPM-01ES and TPM-01ESH)
- * You can delete energies and demands.
- * The menu is password protected.

1 - Connection Diagrams:

Figure-1

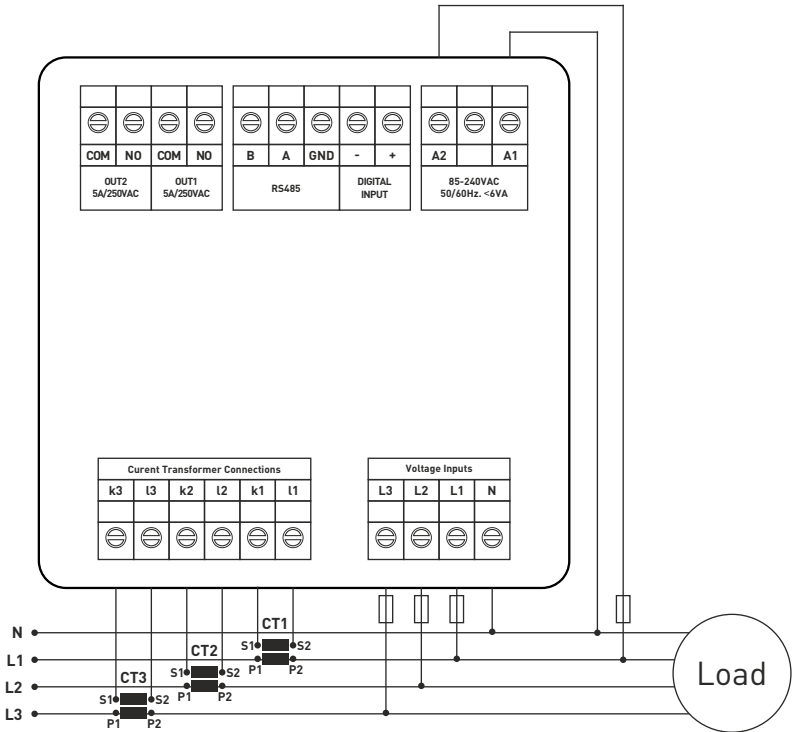

Figure-1: 3P4W connection type: 3 phase current and 3 phase voltage and neutral.

2 - Matters to be Considered in Current Transformer Selection and Connection:

- Note that the value of current transformer is higher than the maximum current drawn from the system.
- It is advisable that the class of the current transformer (it can be written class, klas, ct, kt) is 0.5.
- To avoid the complexity when connecting the current transformer output terminal use different colour cables or give cable numbers.
- Please spread the cables which are connected to current transformer output terminal from remote high voltage lines.
- Please fix current transformers to bara, cable or rail to avoid rattling.

3 - Warnings:

- Please use the device properly according to our directions.
- Please protect LCD screen from sun light.
- Please take 5 cm. space behind the device after the device installation.
- Please fix the device front cover panel with the apparatus that comes with it.
- Please not use device in the damp board.
- Please add a switch or circuit breaker to assembly.
- Please keep switch or circuit breaker close the device or in an easily accessible location by the operator.
- There should be no electricity in the connection cables when assembling device.
- There should be used shielded or twisted cord cable at the non-network-connected input and output lines. These cables should not be passed near the high power lines and the device.
- Assembling and electrical connections must be done by technical staff according to instruction manuel.
- The feed cables should be suitable for IEC 60227 or IEC 60245 requirements.

4 - Device Maintenance :

Turn off energy of the device and disconnect from connections. Clean the device body by using slightly moist or dry cloth. Do not use conductor or other chemical as a cleaning agent matter which is harmful to device. Make connections after the cleaning of device and give energy to device and make sure that device works properly.

5 - General:

TPM-01E/ES/ESH Energy analyzers measures load or voltage, current, $\cos\phi$, active power, reactive power, minimum and maximum values of the load and also measures demands. This analyzer measures current harmonics and voltage harmonics up to 31. harmonics.

6 - First Operation of the Device:

Please read the warnings before powering the device. Make connections of the device according to the connection scheme. When the device is first powered up figure-3 displayed on the screen. Firstly enter the current transformer ratio from the settings menu and if the voltage transformer medium voltage is being measured], enter the voltage transformer ratios.

7- Introduction of Screen:

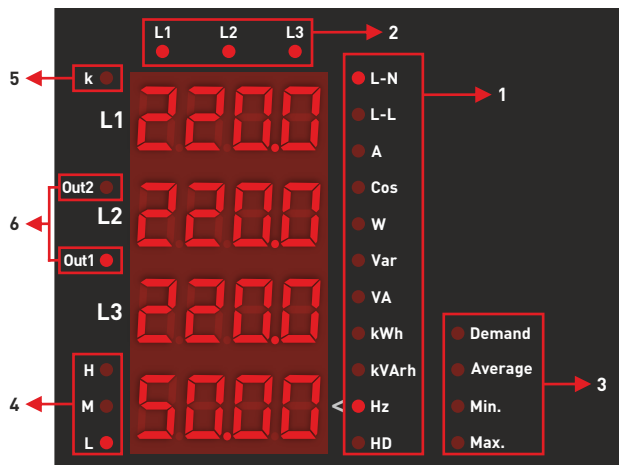

Figure-2

1 - Shows the unit of the value.

L-N: Phase-Neutral Voltage,
L-L: Phase-Phase Voltage,
A: Current,
Cos: Cosinus Fi and Power Factor,
W: Watt (Active Power),
 (If it is shown with "-", it is Export Active Power.),
Var: Reactive Power,
 (If it is shown with "-", it is Capacitive Power.),

VA: Apparent Power,
kWh: Active Energy,
kVArh: Reactive Energy,
 (If it is shown with "-", it is Capacitive Energy.),
Hz: Frequency,
HD: Harmonics.

2 - Shows which phase the value belongs to. (L1, L2, L3)

3 - Specifies the type of value shown. Minimum, maximum, average and demand.

Min.: Indicates that the values shown are minimum. (Period: 2 seconds.)

Max.: Indicates that the values shown are maximum. (Period: 2 seconds.)

Average: Indicates that the values shown are average. (Period: 5 minutes.)

Demand: Indicates that the values shown are demand. (Period: 15 minutes.)

4 - It shows the magnitude of the current value drawn from the system.

L: This LED will light if the current value in any phase is 1A or less.

M: This LED will light if the current value in any phase is between 1A and 4A.

H: This LED will light if the current value in any phase is 4A or above.

5 - When the value shown on the screen is greater than 9999, the "k" led lights on.





Ex.: When the voltage value in the system is 34500V, the value to be read on the screen will be 34.50.

6 - Shows the status of the relay.

Ex.: If the Out2 led is on, the Out2 contact is active (energised), if the led is off, it is passive (de-energised).

Ex.: In the above screen (Figure-2), the phase-neutral voltage values and Hz (frequency) value of L1, L2 and L3 are shown. The current drawn from the system is between 0A and 1A and Out1 contact is active.

8 - Introduction of Buttons:

- 
ESC: Press this button while in menu to exit the menu without saving the values. When this button is pressed while not in the menu, the screen always shows figure-3.
- 
SET: This button enters menu/parameter. It records the changes of parameters and remove from parameter.
- 
DOWN: This button enables to fast progress between the values that are measured out of menu. Changes the value while inside the parameters in the menu.
- 
RIGHT: This button allows to progress by displaying the measured values outside the menu together with the details. It allows navigation between parameters when pressed in menu. In the parameter, it allows to transition between steps and parameters.

9 - Progress On Screen Information:

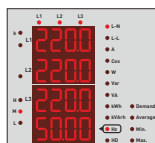

Figure-3



Figure-4

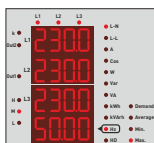

Figure-5

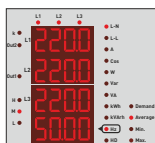

Figure-6

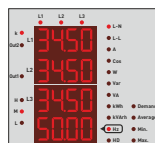

Figure-7

Figure-3: Shows the voltage values between the phase and neutral and the frequency value.

Figure-4 is displayed on the screen when you press the right button.

Figure-4: Shows the minimum voltage values between the phase and neutral and the frequency value.

Figure-5 is displayed on the screen when you press the right button.

Figure-5: Shows the maximum voltage values between the phase and neutral and the frequency value.

Figure-6 is displayed on the screen when you press the right button.

Figure-6: Shows the average voltage values between the phase and neutral and the frequency value.

Figure-8 is displayed on the screen when you press the right button.

NOTE: When the phase-neutral voltage values are higher than 9999, "k" led lights up.

Ex.: The voltage value of the system in Figure-7 is shown as 34.50, but since the "k" led is lit, the value shown is read by multiplying by 1000. So the voltage value in the system is 34500V.

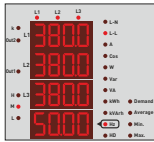

Figure-8



Figure-9



Figure-10

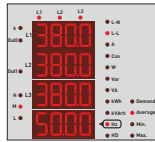

Figure-11

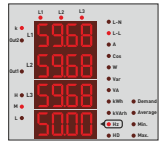

Figure-12

Figure-8: Shows the voltage values between the phase and phase and the frequency value. Figure-9 is displayed on the screen when you press the right button.

Figure-9: Shows the minimum voltage values between the phase and phase and the frequency value. Figure-10 is displayed on the screen when you press the right button.

Figure-10: Shows the maximum voltage values between the phase and phase and the frequency value. Figure-11 is displayed on the screen when you press the right button.

Figure-11: Shows the average voltage values between the phase and phase and the frequency value. Figure-13 is displayed on the screen when you press the right button.

NOTE: When the phase-phase voltage values are higher than 9999, "k" led lights up. Ex.: The voltage value of the system in Figure-12 is shown as 59.68, but since the "k" led is lit, the value shown is read by multiplying by 1000. So the voltage value in the system is 59680V.

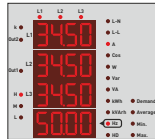

Figure-13

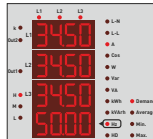

Figure-14

Figure-13: Shows the current values and frequency values of each phase. Figure-14 is displayed on the screen when you press the right button.

Figure-14: Shows the current demand (Dmd*) values and frequency values of each phase. Figure-15 is displayed on the screen when you press the right button.



Figure-15



Figure-16



Figure-17



Figure-18

Figure-15: Shows the active power (P) values of the L1 phase. Figure-16 is displayed on the screen when you press the right button.

Figure-16: Shows the active power demand (Dmd*)(P) values of the L1 phase. Figure-17 is displayed on the screen when you press the right button.

Figure-17: Shows the active power (P) values of the L2 phase. Figure-18 is displayed on the screen when you press the right button.

Figure-18: Shows the active power demand (Dmd*)(P) values of the L2 phase. Figure-19 is displayed on the screen when you press the right button.

*: Demand measurement feature is not available in TPM-01E.



Figure-19



Figure-20



Figure-21

Figure-19: Shows the active power demand (Dmd*) (P) values of the L3 phase. Figure-20 is displayed on the screen when you press the right button.

Figure-20: Shows the active power demand (Dmd*) (P) values of the L2 phase. Figure-22 is displayed on the screen when you press the right button.

NOTE: If the active power is in the "--" direction (export), the value shown will be as in Figure-21. (It is indicated with the "--" sign.) Since the example in the figure is given for the L1 phase, it appears as "--PL1" on the screen.



Figure-22



Figure-23



Figure-24

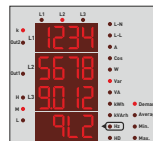

Figure-25

Figure-22: Shows the reactive power (Q) values of the L1 phase. Figure-23 is displayed on the screen when you press the right button.

Figure-23: Shows reactive power (Q) demand (Dmd*) values of L1 phase. Figure-24 is displayed on the screen when you press the right button.

Figure-24: Shows the reactive power (Q) values of the L2 phase. Figure-25 is displayed on the screen when you press the right button.

Figure-25: Shows reactive power (Q) demand (Dmd*) values of L2 phase. Figure-26 is displayed on the screen when you press the right button.



Figure-26



Figure-27



Figure-28

Figure-26: Shows the reactive power (Q) values of the L3 phase. Figure-27 is displayed on the screen when you press the right button.

Figure-27: Shows reactive power (Q) demand (Dmd*) values of L3 phase. Figure-29 is displayed on the screen when you press the right button.

NOTE: If the reactive power is shown with a "--" sign as in Figure-28, it means "capacitive reagent", if it is shown without a sign, it means "inductive reagent". Figure-29 is displayed on the screen when you press the right button.

Since the example in the figure is given for the L1 phase, it appears as "--q1" on the screen.



Figure-29



Figure-30

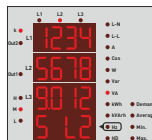

Figure-31

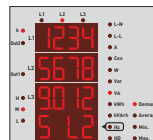

Figure-32

Figure-29: Shows the apparent power (S) values of the L1 phase. Figure-30 is displayed on the screen when you press the right button.

Figure-30: Shows apparent power (S) demand (Dmd*) values of L1 phase. Figure-31 is displayed on the screen when you press the right button.

Figure-31: Shows the apparent power (S) values of the L2 phase. Figure-32 is displayed on the screen when you press the right button.

Figure-32: Shows apparent power (S) demand (Dmd*) values of L2 phase. Figure-33 is displayed on the screen when you press the right button.



Figure-33

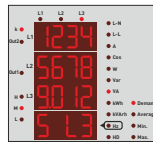

Figure-34

Figure-33: Shows the apparent power (S) values of the L3 phase. Figure-34 is displayed on the screen when you press the right button.

Figure-34: Shows apparent power (S) demand (Dmd)* values of L3 phase. Figure-35 is displayed on the screen when you press the right button.

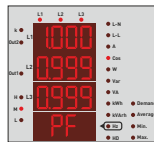

Figure-35

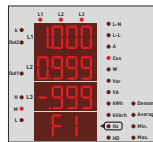

Figure-36

Figure-35: Shows the power factor (PF) values of each phase. Figure-36 is displayed on the screen when you press the right button.

Figure-36: Shows the cosinus (FI) values of each phase. Figure-37 is displayed on the screen when you press the right button.

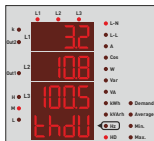

Figure-37

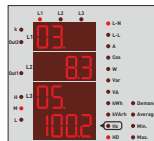

Figure-38

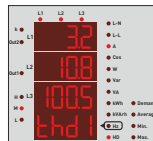

Figure-39

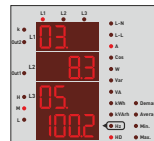

Figure-40

Figure-37: Shows the total voltage harmonic distortion value (THD-V)* values for each phase. Figure-38 is displayed on the screen when you press the right button.

Figure-38: Shows the voltage harmonic values up to 31st* harmonic of each phase, with 2 values on each screen. When you press the right button, the values of the L2 and L3 phases are displayed on the screen respectively.

Figure-39: Shows the total current harmonic distortion value (THD-I)* values for each phase. Figure-40 is displayed on the screen when you press the right button.

Figure-40: Shows the current harmonic values up to 31st* harmonic of each phase, with 2 values on each screen. When you press the right button, the values of the L2 and L3 phases are displayed on the screen respectively.

Figure-41: Shows the import active energy values of the sum of the phases. Figure-42 is displayed on the screen when you press the right button.



Figure-41



Figure-42



Figure-43



Figure-44

Figure-41: Shows the import active energy values of the sum of the phases. Figure-42 is displayed on the screen when you press the right button.

Figure-42: Shows the import active energy value of the L1 phase. Figure-43 is displayed on the screen when you press the right button.

Figure-43: Shows the import active energy value of the L2 phase. Figure-44 is displayed on the screen when you press the right button.

Figure-44: Shows the import active energy value of the L3 phase. Figure-45 is displayed on the screen when you press the right button.



Figure-45



Figure-46



Figure-47



Figure-48

Figure-45: Shows the export active energy values of the sum of the phases. Figure-46 is displayed on the screen when you press the right button.

Figure-46: Shows the export active energy value of the L1 phase. Figure-47 is displayed on the screen when you press the right button.

Figure-47: Shows the export active energy value of the L2 phase. Figure-48 is displayed on the screen when you press the right button.

Figure-48: Shows the export active energy value of the L3 phase. Figure-49 is displayed on the screen when you press the right button.

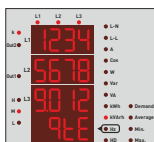

Figure-49



Figure-50

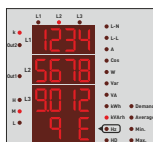

Figure-51



Figure-52

Figure-49: Shows the inductive reactive energy values of the sum of the phases. Figure-50 is displayed on the screen when you press the right button.

Figure-50: Shows the inductive reactive energy value of the L1 phase. Figure-51 is displayed on the screen when you press the right button.

Figure-51: Shows the inductive reactive energy value of the L2 phase. Figure-52 is displayed on the screen when you press the right button.

Figure-52: Shows the inductive reactive energy value of the L3 phase. Figure-53 is displayed on the screen when you press the right button.



Figure-53



Figure-54



Figure-55



Figure-56

Figure-53 Shows the capacitive reactive energy values of the sum of the phases. Figure-54 is displayed on the screen when you press the right button.

Figure-54: Shows the capacitive reactive energy value of the L1 phase. Figure-55 is displayed on the screen when you press the right button.

Figure-55: Shows the capacitive reactive energy value of the L2 phase. Figure-56 is displayed on the screen when you press the right button.

Figure-56: Shows the capacitive reactive energy value of the L3 phase. Figure-57 is displayed on the screen when you press the right button.



Figure-57



Figure-58

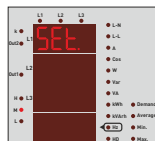

Figure-59

Figure-57: Shows voltage unbalance*. Figure-58 is displayed on the screen when you press the right button.

Figure-58: Shows current unbalance*. Figure-59 is displayed on the screen when you press the right button.

Figure-59: Used to enter the menu to make settings related to the device. When you press the right button again on this screen, the password screen for entering the menu is displayed. (Figure-60)

*: Current and voltage unbalance measurement feature is not available in TPM-01E.

10 - Fast Forwarding of Screen Information:

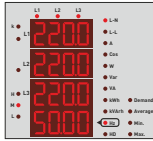

Figure-3

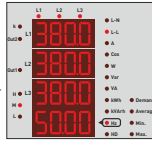

Figure-8

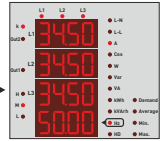

Figure-13

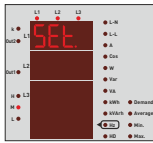

Figure-59



Figure-57*



Figure-41

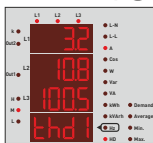

Figure-39*



Figure-37*

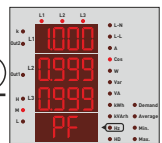

Figure-29

When the device is energised, figure-3 is displayed.
 When you press the down button, figure-8 is displayed.
 When you press the down button, figure-17 is displayed.
 When you press the down button, figure-15 is displayed.
 When you press the down button, figure-13 is displayed.
 When you press the down button, figure-19 is displayed.
 When you press the down button, figure-22 is displayed.
 When you press the down button, figure-24 is displayed.
 When you press the down button, figure-26 is displayed.
 When you press the down button, figure-29 is displayed.
 When you press the down button, figure-31 is displayed.
 When you press the down button, figure-33 is displayed.
 When you press the down button, figure-35 is displayed.
 When you press the down button, figure-37 is displayed.
 When you press the down button, figure-39 is displayed.
 When you press the down button, figure-41 is displayed.
 When you press the down button, figure-45 is displayed.
 When you press the down button, figure-49 is displayed.
 When you press the down button, figure-53 is displayed.
 When you press the down button, figure-57 is displayed.
 When you press the down button, figure-58 is displayed.
 When you press the down button, figure-59 is displayed.
 Press ESC to return to the top.

Figure-3: Shows the phase-neutral voltage(V) values.

Figure-8: Shows the phase-phase voltage(V) values.

Figure-13: Shows the current (I) values.

Figure-15: Shows the active power(P) values.

(Shows the active power values of the phases L1, L2 and L3 respectively.)

Figure-22: Shows the reactive power(Q) values

(Shows the reactive power values of the phases L1, L2 and L3 respectively.)

Figure-29: Shows the apparent power(S) values

(Shows the apparent power values of the phases L1, L2 and L3 respectively.)

Figure-35: Shows the power factor(PF) values

Figure-37: Shows the total voltage harmonic distortion values.

Figure-39: Shows the total current harmonic distortion values.

Figure-41: It shows the total active import energy values.

(It shows total active import, active export, inductive and capacitive energy values respectively.)

Figure-57: Shows the voltage unbalance value.

(It shows the voltage and current unbalance values respectively.)

Figure-59: Used to enter the menu to make settings related to the device.

*: Current/voltage unbalance measurement feature is not available in TPM-01E.

11 - Menu Structure:

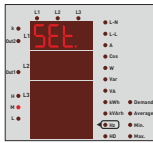

Figure-59



Figure-60



Figure-67**



Figure-61



Figure-62



When you press the right button while the figure-59 is on the screen, the figure-60 password entry screen is displayed. If a password has been created, enter the password and press the set button.

If password is not created before, when you press set button while password value is "0000", you can enter menu and figure-61 comes to the screen.

By pressing the right button in the menu, you can scroll through the parameters. Press the set button to set the parameters. Press the Esc button to exit the menu.



Figure-66*

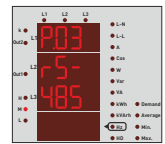

Figure-63*



Figure-65



Figure-61: It is used to enter the current transformer ratio.

Figure-62: It is used to enter the voltage transformer ratio.

Figure-63: It is used to make communication settings.

(RS485 ModBus RTU Settings)

Figure-64: It is used to delete Energy and Demand records.

Figure-65: It is used to set the password.

Figure-66: It is used to assign Relay 1.

Figure-67: It is used to assign Relay 2.



Figure-64



*: TPM-01E does not have relay output and ModBus communication feature.
 **: TPM-01ES has 1 relay output, TPM-01ESH has 2 relay outputs.

12 - Setting the Current Transformer Ratio:

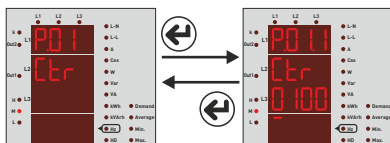

Figure-61



Figure-68

Example: 100/5A current transformer ratio (multiplier value) is 20. The CTR value needs to be set to 0020.

13 - Setting the Voltage Transformer Ratio:

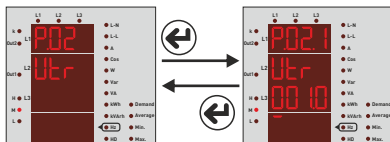

Figure-62



Figure-69

Example: Medium voltage (M.V.) = Enter the ratio of the voltage transformer that converts 34.500V to 110V. The ratio (multiplier) is calculated as $34,500/110 = 313,6$ voltage transformer ratio. The VTR value must be set to 313.6.

To change the current transformer ratio, press the set button while the figure-61 is on the screen. Figure-68 comes to the screen. Press right button to move between digits. Press the down button to change the value of the digit. You can change the digit value which is the underline. When you press the set button after entering the ratio, the current transformer ratio is recorded and the screen shows figure-61. You can scroll through the parameters in the menu by pressing the right button or you can exit the menu by pressing the Esc button.

To change the voltage transformer ratio, press the set button while the figure-62 is on the screen. Figure-69 comes to the screen. Press right button to move between digits. Press the down button to change the value of the digit. You can change the digit value which is the underline. When you press the set button after entering the ratio, the voltage transformer ratio is recorded and the screen shows figure-62. You can scroll through the parameters in the menu by pressing the right button or you can exit the menu by pressing the Esc button.

14 - RS485 Remote Communication Settings (ModBus RTU):

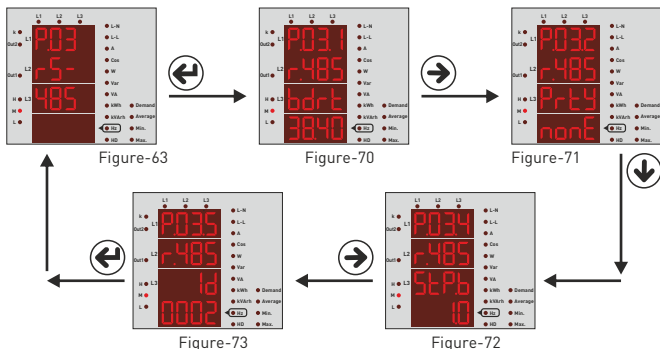

To change the RS-485 remote communication settings*, press the set button while figure-63 is on the screen. Figure-70 is displayed on the screen (Baudrate value). Here 4 parameters can be set, you can switch between these parameters by pressing the right button. Press the down button to change the value of the parameter on the screen. Baudrate (bdr - communication speed) means Parity Bit (PrTY), Stop Bit (StP.b) and Modbus ID (ID - the number that identifies the device on the RS-485 line). When you press the set button, the changes are saved and the figure-36 is displayed on the screen. You can scroll through the parameters in the menu by pressing the right button or you can exit the menu by pressing the Esc button.

Modbus ID (MBID) value; when more than one devices (Energy Analyzer or etc.) connect to a gateway ModBus address must be different. In such cases, enter a different value from other devices.

Baudrate(br): 1200 - 38400 bps, **Parity(PrTY):** None, **Stop bits:** 1, **ModBus ID(Id):** 1 - 247.

Note: If the cable length in the RS485 communication line is too high (> 100m), connect the 120R resistor parallel to the A-B (RS-485) terminal of the begin and end of the communication line to avoid data loss.

15 - Deleting Energy and Demand Records:

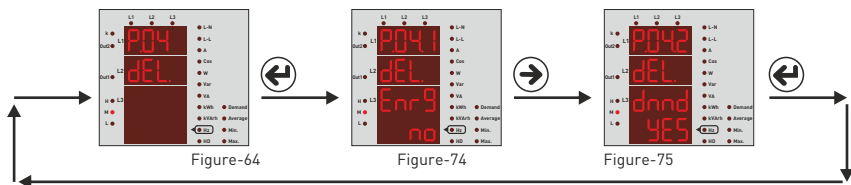

To delete the records, press the set button while figure-64 is on the screen. Figure-74 comes to the screen. You can delete 2 records here. Energy (Enr9) ve Demand (dnnd). You can switch between these parameters by pressing the right button. Then change the value of the parameter you want to delete to "yes" by pressing the down button. The value of the record that you do not want to delete should remain "no". When you press the set button, only the records whose value is changed to "yes" are deleted and figure-64 is displayed on the screen. You can scroll through the parameters in the menu by pressing the right button or you can exit the menu by pressing the Esc button.

16 - Enter Password Value:

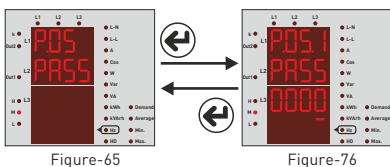

To change the password, press the set button while figure-65 is on the screen. Figure-76 is displayed on the screen. Press right button to move between digits. Press the down button to change the value of the digit. You can change the value of the digit displayed with the underline. When you press the set button after entering the password, the new password is saved and figure-65 is displayed on the screen. You can scroll through the parameters in the menu by pressing the right button or you can exit the menu by pressing the Esc button.

17 - Assigning Tasks to Relay1 and Relay2:

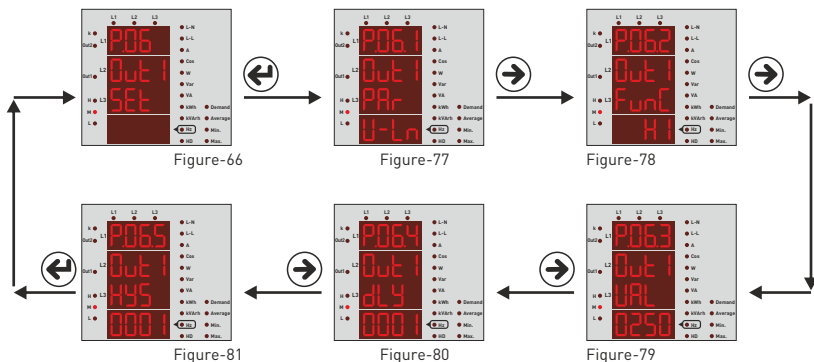

To assign a task to relay 1 (Out1), press the set button while there is figure-66 on the screen. The value of figure-77 Parameter (whichever parameter was last remained) is displayed. Here, 5 parameters can be set, you can switch between these parameters by pressing the right button. Press the down button to change the value of the parameter on the screen. Parameter (PAR.), Function (Func.) Value (VAL.), Delay Time (dLy.) and Hysteresis Value (HYS.). When you press the set button after making the adjustments, the task is assigned to relay1 and figure-66 is displayed on the screen. You can scroll through the parameters in the menu by pressing the right button or you can exit the menu by pressing the Esc button.

Parameters (Par): Voltage (ULn), current (ILn), total current (Ilt), total harmonic distortion belong to Voltage (thdU), total harmonic distortion belong to Current (thdI), power factor (PF), voltage Unbalance (U Un), current Unbalance (I Un), digital input (dl n) and off (OFF).

Function (Fun): Functions to be applied for parameters: if higher than value (hl) and lower than value (LO).

Value(Val): The value to be set for the parameters.

Delay Time (dLY): When the conditions set for the relay have occurred or disappeared, it is time to wait for the relay to get energised on or de-energised.

Histerisiz Değeri (HyS): The tolerance value entered for the set value for energizing or de-energizing the relay when the condition set for the relay has disappeared. The value is entered in %.

Örnek: Example: High voltage is 250V and hysteresis value is %2 (5V). When 250V voltage is applied to the device, the device will enter into to error. The voltage will have to drop to 245V to get out of the error.

(High Voltage Set Value - Hysteresis Value)

Note1: The task assignment of relay 2 is assigned in the same way as relay 1. While in menu for relay 2 assignment. The entrance should be done from the figure-67.

Note2: To use the digital input parameter, 9V-24DC energy should be applied from the entrance of input to the device. If the device is required to energize the relay when energy is applied to the digital input, HI function is selected. If the device is required to energize the relay when no energy is applied to the digital input, Lo function is selected. The change of the voltage at the data input should be minimum at one second (1Hz) **The Digital Input is only available on the TPM-01ESH.**

Example: If the voltage value exceeds 250V, the relay 1 gets energised after 5 seconds. De-energised after 5 seconds when voltage value drops to 245.

Parameter (PAR) = ULn, function (fun) = hl, value (VAL) = 250V, delay time (dLY) = 5 seconds and hysteresis value (HyS) = %2(5V) should be set. If the relay is set in this way, the relay 1 is gets energised after 5 seconds when one of the voltage values rises above 250V. When one of the voltage values drops to 245V, the relay is de-energised after 5 seconds.

18 - Menu Values Table:

Parameter Number	Parameter	Unit	Factory Value	Minimum Value	Maximum Value
Ctr	Current Transformer Ratio	-	1	1	1000
Vtr	Voltage Transformer Ratio	-	1.0	0.1	999.9
br	Baudrate	bps	9600	1200	38400
-	Stop bits	-	1	1	2
-	Data bits	-	8	-	-
-	Parity	-	none	none, even, odd	
Id	ModBus ID	-	1	1	247
En	Deleting Total Energy	-	No	Yes	No
dE	Deleting Demand Values	-	No	Yes	No
PASS	Password	-	0	0	9999
Par	Parameter	-	OFF	OFF, ULn, Iln, Ilt, thdU, thdI, PF, U Un, I Un, dl n	
Fun	Function	-	High	Low	High
UAL	ULn (Voltage)	Volt	vtr x 10	vtr x 10	vtr x 500
	Iln (Current)	Ampere	{ctrx10}/100	{ctrx10}/100	{ctrx500}/100
	Ilt (Total Current)	Ampere	{ctrx3x10}/100	{ctrx3x10}/100	{ctrx3x500}/100
	thdU (Total Voltage Harmonic)	%	1	1	50
	thdI (Total Current Harmonic)	%	1	1	50
	PF (Power Factor)	%	0.50	0.50	0.99
	U Un (Voltage Unbalance)	%	1	1	50
	I Un (Current Unbalance)	%	1	1	50
dLY	Delay Time	second	0	1	1000
HyS	Hysteresis Value	%	0	1	10

19- Dimensions:

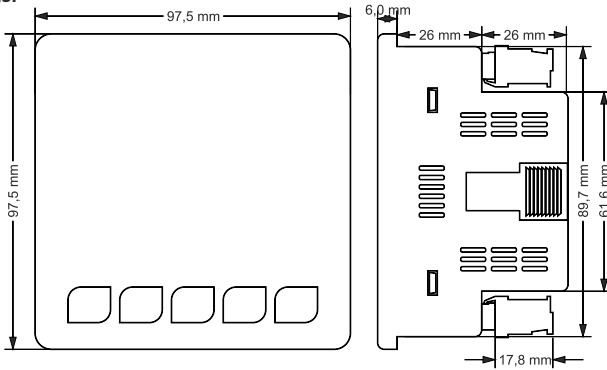

20 - Technical Specifications:

Operating Voltage	85V - 240V AC
Operating Frequency	50 / 60 Hz
Operating Power	< 10VA
Operating Temperature	-20°C....55°C
Voltage Input	5V -330V AC
Voltage Meas. Range	5V - 330kV
Current Input	10mA - 5.5A
Current Meas. Range	10mA - 5.500A
Voltage, Current Accuracy	%±0.5
Active Accuracy	%±1
Reactive Accuracy	%±2
Supported Connection	3P4W
Current Transformer Ratio	1....1000
Voltage Transformer Ratio	1,0....999,9
Harmonic Voltage Meas.	3 - 31
Harmonic Current Meas.	3 - 31
Communication	RS485 MODBUS RTU
Baudrate	1200bps - 38400bps
Stop Bit	1 or 2
Parity	None, Even, Odd
Display*	4 x 4 Digit 14mm LED Display 24 x LEDs
Relay Output	2 x 3A/250VAC (Resistive Load)
Digital Input	1 x 9V - 24VDC
Weight	<300Gr.
Protection Class	IP41(Font Panel), IP20(Body)
Panel Hole Sizes	91mm x 91mm
Connection Type	Plug-in terminal connection
Cable Diameter	1.5mm ²
Mounting	Mounting on panel front cover
Operating Altitude	<2000meters

* : It may vary depending on the product model.

22 - Contact Information:

Muratpaşa Mah. Uluyol Cad.
İşkent Sanayi Sitesi, E-Blok, 1.Kat
BAYRAMPAŞA / İSTANBUL / TÜRKİYE
Tel: 0212 578 04 38 - 48 | Fax: 0212 578 04 36
www.tense.com.tr | info@tense.com.tr

21 - Index:

Konu:	Page
1 - Connection Diagrams:	1
2 - Matters to be considered in current transformer selection and connection:	2
3 - Warnings:	2
4 - Device Maintenance:	2
5 - General:	2
6 - First Operation of the Device:	2
7 - Screen Presentation:	3
8 - Button Presentation:	4
9 - Progress on Screen Information:	4
10 - Fast Progress on Screen Information:	9
11 - Menu Structure:	10
12 - Set up the Current Transformer Ratio :	11
13 - Set up the Voltage Transformer Ratio :	11
14 - Remote Communication Settings of Rs485 (ModBus):	11
15 - Delete Energy and Demand Records:	12
16 - Enter Password Value:	12
17 - Assigning Tasks to Relay1 and Relay2:	12
18 - Menu Values Table:	13
19 - Dimensions:	14
20 - Technical Specifications:	14
21 - Index:	14
22 - Contact Information:	14



Energy and
Compensation
Tracking System
www.tenseenerji.com