



ROG-MT18 SVC (MV and LV) RGT-MT18 SVC (LV) USER MANUAL



Our products with ROG-MT18 SVC and RGT-MT18 SVC codes are TSE certified.

Contents

About RGT-MT	1
Features	1
Warnings	2
Considerations in Compensation	2
What to Look Out for in the Selection and Connection of Current Transformer?	3
How to Connect the NTC to the Panel Temperature?	3
Maintenance of the Device	3
Screen Intro	4
1 Measurements Page 1	5
1.1 Voltage Page	5
1.2 Voltage & Current Page	5
1.3 Cosinus Page	6
1.4 Total Energy Page	6
1.5 Instant Powers Page	6
1.6 Reactive Ratios Page	6
1.7 Power Analysis Page	7
1.8 Step Values Page	7
2 Measurements Page 2	7
2.1 Voltage & Frequency Page	8
2.2 THD-V THD-I Page	8
2.3 Power Factor Page	8
2.4 Harmonic Voltage Page	8
2.5 Harmonic Current Page	8
2.6 Demand Page	9
2.7 Min / Max / Average Page	9
3 Settings Screen	9
3.1 Current Transformer Settings	10
3.1.1 Changing the Voltage Transformer Value	10
3.1.2 Changing the Current Transformer Value	10
3.1.3 Current Transformer Test	10

3.2 Voltage Harmonic Protection	11
3.3 Current Harmonic Protection	11
3.4 Generator Compensation Setting	11
3.5 Voltage Protection	11
3.6 Inductive and Capacitive Alarm	12
3.7 Compensation Target Setting	12
3.8 Temperature Control	12
3.9 ModBus Settings	12
3.10 Step Settings Page	14
3.10.1 Step Times	14
3.10.2 Automatic Step Measurement	15
3.10.3 Step Test	15
3.10.4 Entering the Manual Step Value	15
3.10.5 Entering the Manual SVC Value	16
3.10.6 PFC Setting	16
3.11 Device Settings	16
3.11.1 Device Installation	17
3.11.2 Language Selection	17
3.11.3 Password Settings	17
3.11.4 Delete Registration	18
3.11.5 Date and Time Settings	18
3.11.6 Factory Settings	18
How to Select a Home Page?	19
How to Install the Device?	20
How to Change the Current Transformer Value?	20
How is the Current Transformer Test Done?	21
How to Measure the Step?	21
How to Enter the Manual Step Value?	22
How to Enter the Manual SVC Value?	22
How to Perform a Step Test?	23

Contents

How to Return to Factory Settings?	23
How to Return to the Default Menu Settings?	23
Medium Voltage Three Phase (3P4W) Connection Scheme	24
Low Voltage Three Phase (3P4W) Connection Scheme	25
Low Voltage Mono Phase (1P2W) Connection Scheme	26
Connecting PFC and Inductive Load Driver (SVC)	27
Remote Communication with RS485 (GSM-MOD)	28
Remote Communication with RS485 (ETH-MOD)	28
Calculation Chart of Capacitor According to Connection	29
Step Creation According to Power Analysis Examples?	30
Dimensions	31
Factory Default Values	32
Technical Specifications	33
Contact Information	33

About the Device

It is designed to reduce reactive (inductive and capacitive) power that comes from the network and loads do not use. If the inductive reactive power is attracted from the network, it interferes by attracting capacitor at the appropriate step. If capacitive reactive power is attracted from the network, it interferes by attracting shunt reactor at the appropriate step. Thus it endeavors to reduce the inductive/active and capacitive/active rates of the system.

It is designed to make more sensible compensation at the unbalanced inductive and capacitive systems with SVC step.

Features

- ◆ 5 "Easy to install and use with touch (resistive) display
- ◆ TCR (SVC) Connectable
- ◆ Generator Input and Generator Compensation
- ◆ Remote Communication with RS485 (Computer Communication)
- ◆ Temperature Measurement and Control
- ◆ Compensation for Inductive and Capacitive Systems
- ◆ Manual Step Value Enterable
- ◆ Single, Two, and Three Phase Capacitor and Shunt Reactor can be Connected
- ◆ Turkish and English Language Option
- ◆ Voltage, Harmonic Current/Voltage, Inductive and Capacitive Alarm Output
- ◆ Temperature Alarm Output
- ◆ Intervention, Discharge and Settling Times can be Adjustable
- ◆ Current Harmonics can be Observed Up To 61st Harmonics
- ◆ Voltage Harmonics can be Observed Up To 61st Harmonics
- ◆ Cosine Values of Each Phase Can Be Observed
- ◆ Power Factor Values of Each Phase can be Observed as Graphically
- ◆ Capacitive / Active and Inductive / Active Ratios can be Observed as Grafically.
- ◆ Total Energies (Import/Export) can be Observed.
- ◆ THD-V and THD-I values of Each Phase can be Observed.
- ◆ Creating Power Analysis (20 samples 9999 min.)
- ◆ Demand Registration (Active & Reactive & Apparent Power and Current Demand)
- ◆ Min, Max and Average Values of Current and Voltage of Each Phase can be Observed.
- ◆ Real Date and Time
- ◆ Encrypted Protection
- ◆ Same Aging in Steps

Warnings

- Use the device according to our instructions.
- Avoid direct sun light in order not to harm the LCD screen.
- Leave at least 10 cm of space behind the device after mounting.
- Fix the device with apparatus which comes within the device by avoiding any kind of shake on the front cover of the board.
- Balance the inner and outer heat in the metal boards. Otherwise because of the temperature difference that originates from the dampish surrounding, water droplets occurs on the ceiling of the board and this situation is dangerous for the open connected buses.
- Mark the switch and circuit breaker as the connection tripping element for the device.
- Keep the switch and circuit breaker close to the device and easily accessible by the operator.
- There must be no electricity in the connection cables when assembling.
- Screened and twisted cord cables should be used on the input and output lines without connection to the Mains (network). These cables should not pass near high-Voltage lines and devices.
- Do not touch the touchscreen with a hard, sharp object.

Matters to Be Considered In Compensation

- Compensation starts with the regulations of the load distribution of the Electrical wiring in a balanced way that belongs to the system.
- In ROG-MT18 SVC; For the current transformer test, connect three phase capacitors in $1/40$ (*) of the accrual rate (**) value to the first three stages (C1, C2, C3) of the device. (* : The total value of the first three levels.) (**: Voltage Transformer Ratio x Current Transformer Ratio)
- In RGT-MT18 SVC; For the current transformer test, connect three phase capacitors in $1/40$ (*) of the current transformer value to the first three stages (C1, C2, C3) of the device. (* : The total value of the first three levels.)
- Do not define step number and capacitor values randomly where has rapid load changing and where huge amount of load is distributed randomly.
- You can get benefit from the examples which are in the Power Analysis, in order to compensate more effectively to the unbalanced loads in the system.
- It is advisable to add new steps at the same value for the lifespan of the commonly used step's conductor and capacitor.
- While preparing compensation board be careful about that you should easily add new steps for probable changings (load adding or excluding) that can occur subsequently.
- While making current transformer test and measurement of the step, be careful about avoiding rapid load changing on the system as much as possible.
- Choose the automatic fuse current values used in steps according to the power of the capacitor and reactor and point as connection removing member.
- Use different automatic fuse for each feeding inductor of the step conductors.
- Use compensation conductor sand discharge inductors at the steps.
- Unique phase connection at the three phase systems is only appropriate for balanced load attraction. Otherwise desired rates cannot be obtained.

Point to Pay Attention About The Choice And Connection of the Current Transformers

- Be careful about the value of the current transformer to be more than the maximum current which could be/is attracted from the system.
- It is recommended that class of the current transformers (it can be also mentioned class, klas, kl, cl) should be 0,5 which will be used at the compensations.
- Only X/5A and X/1A current transformers can be connected to the device.
- Be careful about the absence of any load before the current transformers. Otherwise there can be differences between reactive and counter.
- Current transformer outputs and phase inputs must be in the same order. Connect the k-l terminals of the current transformer connected to the L1 phase to the k1-l1 terminals, the k-l terminals of the current transformer connected to the L2 phase to the k2-l2 terminals and the k-l terminals of the current transformer connected to the L3 phase to the k3-l3 terminals.
- While connecting output of the current transformer terminals in order to avoid confusion, use different coloured cable for each phase or number the cables.
- Pass the cables which is connected to the output of the current transformer far from the high voltage line.
- It is advised that the cables to be used which are connected to current transformer should be minimum 1.5 mm². It is also recommended that the cables should be thickened as the distance increase.
- In order to avoid shake at the current transformers, fix to the bus, cables or rail.

How to Connect the NTC to Inside of the Panel Temperature?

In order to measure the surrounding temperature of the panel, NTC terminal will be attached which comes within the device. NTC's one terminal will be attached to the RS485 connection's GND, the other terminal will be connected to the NTC. When the connection accomplished, panel heat value is seen on the screen. When the connection disconnected or reach to the -40, "NC" sign is seen on the screen.

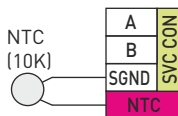

Maintenance of the Device

Turn off the energy of device and disconnect it from the connections. Clean the body of the device with a slightly damp or dry cloth. Do not use conductive or other chemicals that may damage the device as a cleaning materials. After the device is cleaned, make connections and make sure that the device is working by energizing the device.

Screen Introduction

1- Stage connection type display leds.



- 1st Level Three-Phase,
- 2nd Level Double-Phase (L1-L2),
- 3rd Level Double-Phase (L2-L3),
- 4th Level Double-Phase (L3-L1),
- 5th Level Monophase (L1),
- 5th Level Monophase (L2),
- 7th Level Monophase (L3),
- 8th Level Cancel.

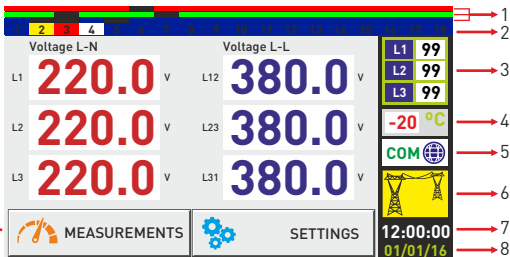

2- Step LEDs:

1 The stage is active. (Capacitor)

1 The stage is active. (Shunt Reactor)

1 The stage is not active. (Capacitor)

1 The stage is not active. (Shunt Reactor)

3- TCR (SVC) Step Indicator:

It shows separately the driving ratios of the mono-phase shunt reactors connected to the SVC. It has no touch feature.



4- Temperature Indicator:

Indoor temperature is shown in °C. When the NTC connection fails or when the temperature it goes below -40 °C, "NC" is written in the value display. It has no touch feature.



5- Remote Communication Indicator:

It displays for 1 second when remote communication with the device. The passive image is displayed when no remote communication is made. It has no touch feature.

Active

Passive

6- System Feed (Voltage) Source Indicator:

Indicates that the system is fed from the network or generator. When voltage (220V) is applied to the generator input, the system is supplied from the generator. If there is no voltage at the generator input, it means that the system is being fed from the network. It has no touch feature.

Generator Supply



Network Supply



7- Hours: Hours: Minutes: Seconds → **12:00:00**

8- Date: Day/Month/Year → **01/01/19**

6- Dynamic Display:

Touch-screen is active on this area. By pressing the buttons in the area, the measured values can be seen and the settings can be changed.

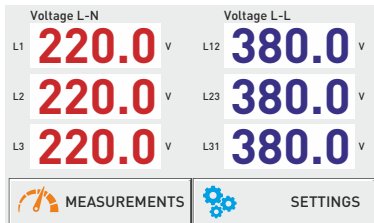

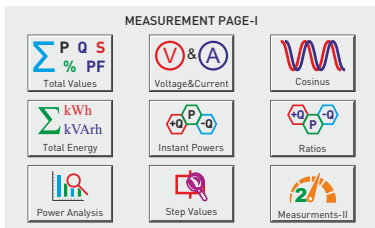

When the Measurements button is pressed, the measurements page-1 comes to the dynamic area. From this page you can switch between Total Values, Voltage & Current, Cosinus, Total Energy, Instantaneous Power, Ratios, Power Analysis, Step Values and Measurements-2 page.

- 1.1 Total Values:** PF, P, + Q, -Q, S values and Reactive Ratios and Offset value are displayed.
 - 1.2 Voltage&Current:** Voltage and current values are shown.
 - 1.3 Cosinus:** The cosinus value is shown in figures and graphs.
 - 1.4 Total Energy:** Total Active, Inductive and Capacitive energies are shown.
 - 1.5 Instant Powers:** Instant active and reactive power are displayed.
 - 1.6 Ratios:** Capacitive/Active and Inductive/Active ratios are shown.
 - 1.7 Power Analysis:** The reactive (inductive and capacitive) records of the system are shown.
 - 1.8 Step Value:** Each phase of step values are shown.
- 2. Measurements-II:** goes to Measurements Page 2.

Measurements **Measurements Page 1** **1.1 Total Values Page**

Total Values		Ratios(%)	
PF	1.000	Ins. Ind.	1.000
P	0.000 kW	Ins. Cap.	0.000
+Q	0.000 kVAr	Tot. Ind.	0.000
-Q	0.000 kVAr	Tot. Cap.	0.000
-S	0.000 kVA	Offset	0.000 kVAr

MEASUREMENTS
 SETTINGS

In this page, Power Factor, Active Power, Inductive Power, Capacitive Power, Apparent Power values and Instant Reactive Ratios, Total Reactive Ratios, Offset value are shown.

Power Factor (PF), Instantaneous Inductive Ratio (Ins.Ind.) and Instantaneous Capacitive Ratio (Ins.Cap) values are calculated according to the Offset value.

On this page, the "Measurements 1" page is displayed when the "Measurements" button is pressed, and the "Settings" page is displayed when the "Settings" button is pressed.

Measurements **Measurements Page 1** **1.2 Voltage & Current Page**

Voltage L-N		Current	
L1	220.0 V	L1	1.358 A
L2	220.0 V	L2	1.453 A
L3	220.0 V	L3	1.289 A

MEASUREMENTS
 SETTINGS

In this page, the phase-neutral voltage values of each phase and the current values of each phase are displayed.

On this page, the "Measurements 1" page is displayed when the "Measurements" button is pressed, and the "Settings" page is displayed when the "Settings" button is pressed.

Measurements Measurements Page 1 1.3 Cosinus Page

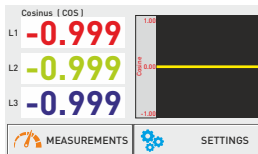

In this page, the cosine values of each phase are displayed in figures and graphics.

On this page, the "Measurements 1" page is displayed when the "Measurements" button is pressed, and the "Settings" page is displayed when the "Settings" button is pressed.

Measurements Measurements Page 1 1.4 Total Energy Page

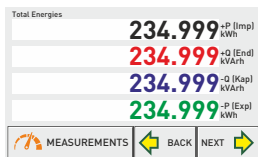

In this page, total energy values (import active, inductive, capacitive and export active) are displayed.

On this page, the "Measurements 1" page is displayed when the "Measurements" button is pressed. When you press the "BACK" and "NEXT" buttons, you can see the Energy for each phase, Energies of tariffs and Energy values of Generators.

Measurements Measurements Page 1 1.5 Instant Powers Page

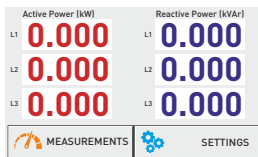

In this page, the active power and reactive power values are displayed.

On this page, the "Measurements 1" page is displayed when the "Measurements" button is pressed, and the "Settings" page is displayed when the "Settings" button is pressed.

Measurements Measurements Page 1 1.6 Reactive Ratios Page

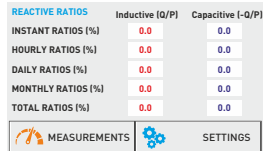

In this page, Capacitive / Active and Inductive / Active ratios are displayed as "%" in Instant, Hourly, Daily, Monthly and Total Rates.

Instant Ratio: The average of the last 5 seconds.

Hourly Ratio: The ratio of the current hour. It is reset at the beginning of every hour.

Daily Rate: The ratio of the current day. Every day is reset at 00:00.

Monthly Rate: The ratio of the current month. The 1st day of each month is reset at 00:00.

Total Ratio: The total rate calculated according to total energy consumption.

To reset Instant, Hourly, Daily and Monthly rates, click on the "Delete Record button, on the "Delete Records?" screen"; In order to reset the total ratios, the "Delete Total Energy Values" button should be used in the "Delete Records?" screen".

Note: Deleting Total Energy Values will reset all ratios.

On this page, the "Measurements 1" page is displayed when the "Measurements" button is pressed, and the "Settings" page is displayed when the "Settings" button is pressed.

Measurements Measurements Page 1 1.7 Power Analysis Page

Power Analysis Samples				Time (min)
L1	L2	L3		
1.	0.00	0.00	0.00	0
2.	0.00	0.00	0.00	0
3.	0.00	0.00	0.00	0
4.	0.00	0.00	0.00	0
5.	0.00	0.00	0.00	0

In this page each reactive (capacitive is marked as (-) power of the phase are recorded with their time.

If expenditure of power is fixed in a stated time, it is recorded as sample. If latter sample is %15 higher than the former, it is recorded as different. If it is %15 less than the former, it is added to the sample. It includes 20 samples in total. It can take samples up to 9999 minutes most.

In this page when you press the Measurements button "Measurements 1" page comes. When you press "BACK" and "NEXT" button, you can pass among the samples.

Measurements Measurements Page 1 1.8 Step Values Page

Step Values				
	L1	L2	L3	Counter
1.	-0.33	-0.33	-0.33	L1-2-3 10
2.	-0.25	0.00	0.00	L1 30
3.	0.00	-0.25	0.00	L2 45
4.	0.00	0.00	-0.25	L3 1
5.	0.00	0.00	0.00	Cancel 0

In this page, the values of capacitor (sign (-) or shunt reactor value (each phase separately), connection type and number of steps usage are displayed.

It is 18+1 step in total. The 19th step is TCR. Three monophasi (one for each phase) shunt reactor are connected to this step. Shunt reactors are connected to driver. Shunt reactors are triggered via the SVC CON connection.

On this page, the "Measurements 1" page is displayed when the "Measurements" button is pressed. When you press the "BACK" and "NEXT" buttons, you can pass from one step to another step.

Measurements 2. Measurements Page 2

MEASUREMENTS PAGE-II

Voltage & Freq.	THD-V THD-I	Power Factor
Volt. Harmonics	Cur. Harmonics	Demand
Min/Max	Main Page	Measurements-I

When the Measurements-II button is pressed, the measurements page-2 comes to the screen on the dynamic area.

From this page, it is possible to switch to Voltage & Frequency, THD-V & THD-I, Power Factor, Harmonic Voltage, Harmonic Current, Demand, Min / Max, Home and Measurements-1 page.

2.1 Voltage & Frequency: Voltage and Frequency values are displayed.

2.2 THD-V/THD-I: Total Harmonic Voltage and Current values are displayed.

2.3 Power Factor: The power factor values are shown in figures and graphs.

2.4 Harmonic Voltage: Values up to the 61st harmonic of each phase are displayed.

2.5 Harmonic Current: Values up to the 61st harmonic of each phase are displayed.

2.6 Demand: Active / Reactive / Apparent power and Current demand values are displayed.

2.7 Min/Max: Current and Voltage Min / Max / Average values are displayed.

Main Page: Go to Main Page.

Measurements-I: Go to Measurements Page 1.

Measurements Measurements Page 2 **2.1 Voltage & Frequency Page**

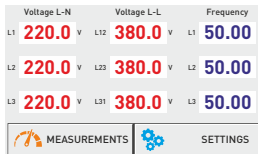

In this page, the phase-neutral and phase-phase voltage values of each phase and the frequency values of each phase are displayed.

On this page, the "Measurements 1" page is displayed when the "Measurements" button is pressed, and the "Settings" page is displayed when the "Settings" button is pressed.

Measurements Measurements Page 2 **2.2 THD-V THD-I Page**

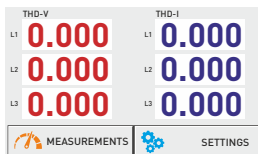

In this page, THD-V (Voltage total harmonic distortion) and THD-I (Current total harmonic distortion) values of each phase are displayed.

On this page, the "Measurements 1" page is displayed when the "Measurements" button is pressed, and the "Settings" page is displayed when the "Settings" button is pressed.

Measurements Measurements Page 2 **2.3 Power Factor Page**

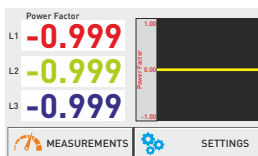

In this page, the Power Factor values are displayed in figures and graphs.

On this page, the "Measurements 1" page is displayed when the "Measurements" button is pressed, and the "Settings" page is displayed when the "Settings" button is pressed.

Measurements Measurements Page 2 **2.4 Harmonic Voltage Page**

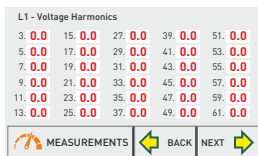

In this page, up to the 61st harmonic of each phase voltage is displayed.

On this page, the "Measurements 1" page is displayed when the "Measurements" button is pressed. When you press the "BACK" and "NEXT" buttons, you can see harmonics belong to the other phases.

Measurements Measurements Page 2 **2.5 Harmonic Current Page**

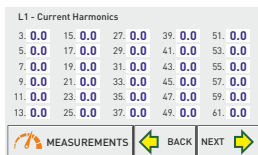

In this page, it is displayed up to the 61st harmonic of each phase current.

On this page, the "Measurements 1" page is displayed when the "Measurements" button is pressed. When you press the "BACK" and "NEXT" buttons, you can see harmonics belong to the other phases.

Measurements Measurements Page 2 2.6 Demand Page

	Current Demand (15min.)		
	Current (A)	Date	Time
L1	0.000	00/00/0000	00:00
L2	0.000	00/00/0000	00:00
L3	0.000	00/00/0000	00:00
Total	0.000	00/00/0000	00:00

--	--	--

In this page, the total current, active power, reactive power and apparent power demand values are displayed with the date and Times.

On this page, the "Measurements 1" page is displayed when the "Measurements" button is pressed. When you press the "BACK" and "NEXT" buttons, you can see other demand values.

Measurements Measurements Page 2 2.7 Min / Max / Average Page

	Current Min-Max-Avg (A) [5min.]		
	Min	Max	Avg
L1	0.000	0.000	0.000
L2	0.000	0.000	0.000
L3	0.000	0.000	0.000

--	--	--

In this page, the minimum (min), maximum (max) and average (avg) values of current and voltage values are displayed. (Values are taken with an average of 5 min.)

On this page, the "Measurements 1" page is displayed when the "Measurements" button is pressed. When you press the "BACK" and "NEXT" buttons, it is toggle between the others.

Settings 3. Settings Screen

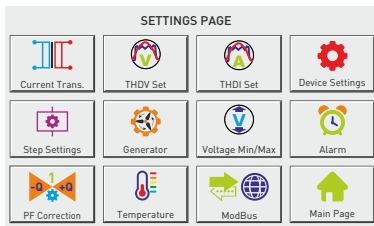

When the Settings button is pressed, the Settings page appears on the screen on dynamic area.

From this page, you can switch to Current Transformer, Harmonic Voltage, Harmonic Current, Device Settings, Step, Generator, Voltage Min / Max, Alarm, Compensation, Temperature, Modbus settings and Main Page.

3.1 Current Transformer : The current transformer test / current transformer value change is made.

3.2 Harmonic Voltage: Harmonic Voltage settings are made.

3.3 Harmonic Current: Harmonic Current settings are made.

3.4 Device Settings: Go to Device settings menu.

3.5 Step: Go to the menu of Step settings.

3.6 Generator: Generator settings are made.

3.7 Voltage Min / Max: Voltage settings are made.

3.8 Alarm: Inductive and Capacitive Alarm settings are made.

3.9 Compensation: Inductive and Capacitive target settings are made.

3.10 Temperature: Temperature Alarm settings are made.

3.11 ModBus: Modbus (Communication) settings are made.

Main Page: Go to Main Page.

Settings **3.1 Current Transformer Settings**



In this page you can start the current transformer test and change the current transformer and voltage transformer value.

On this page, when the "Start Current Transformer Test" button is pressed, the current transformer test is started. When the "Change Current Transformer Value" button is pressed, the current transformer value changing page is displayed on the screen.

When the "Back" button is pressed, the "Settings" page appears on the screen.

Settings **3.1.1 Changing the Voltage Transformer Value**

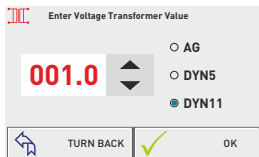

After pressing the change voltage transformer type button, the voltage transformer value is adjusted by pressing the down and up arrow buttons and the voltage transformer type is selected by pressing the voltage transformer types. (only in ROG-MT18 SVC)

Example: Medium voltage (O.G.) = Let's enter the ratio of the voltage transformer that converts 34.500V to 110V.

The ratio (multiplier) = $34,500 / 110 = 313.6$ was calculated as the voltage transformer ratio. The VTR value should be set to 313.6.

Pressing the "Confirm" button, the saved data is recorded and returns to "Settings" page. When the "Return" button is pressed, without recording any value, turns to "Settings" page.

Settings **3.1.2 Changing the Current Transformer Value**

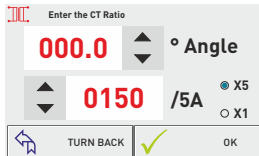

After pressing the change the current transformer value button, the current transformer value is adjusted by pressing the down and up arrow buttons and "X5" or "X1" is selected according to the current transformer type to be used. The test starts automatically when the "Confirm" button is pressed. If there is any problem in the connections, the device will give a warning and will not accept the connection.

Angle Value: It ensures that the angle (DYN angle) deviations in the MV power transformers are recognized on the device and intervened accordingly in order to reduce the differences in power measurements that may occur between the meter and the reactive relay. (ROG-MT18 SVC only)

If the current transformer test is successful and the connection is confirmed, the device starts to measure the step automatically.

Settings **3.1.3 Current Transformer Test**

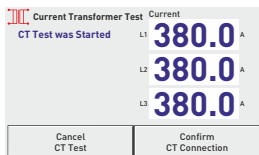

The test starts automatically when the "Start current transformer test" button is pressed. If there are any problems in the connection, the device will give a warning and will not accept the connection.

If the current transformer test is successful and the connection is confirmed, the device starts to measure the step automatically.

Settings 3.2 Voltage Harmonic Protection

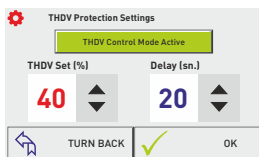

The screenshot shows the 'THDV Protection Settings' screen. At the top left is a gear icon. Below it, the text 'THDV Protection Settings' is displayed. A green bar indicates 'THDV Control Mode Active'. There are two adjustable fields: 'THDV Set (%)' with a value of 40 and 'Delay (sn.)' with a value of 20. Each field has up and down arrow icons. At the bottom, there are two buttons: 'TURN BACK' with a left-pointing arrow icon and 'OK' with a green checkmark icon.

In this page voltage harmonic control mode can be made active or passive, harmonic of total voltage and delay of it can be set. When the set is active the colour of the button's writing becomes green, and when the set is passive it becomes red. When the control mode is active and the total voltage harmonics get higher than the setted harmonic values, the device waits as much as delay; after the time of the delay comes to an end it makes the compensation stop

and "High Harmonic Voltage" warning comes to the screen. Also "ALR1" is on. When the control mode is passive, the device doesn't make voltage harmonic control. Pressing the "Confirm" button, the saved data is recorded and returns to "Settings" page. When the "Return" button is pressed, without recording any value, turns to "Settings" page.

Settings 3.3 Current Harmonic Protection

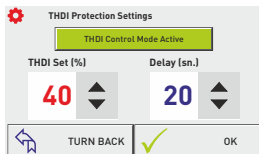

The screenshot shows the 'THDI Protection Settings' screen. At the top left is a gear icon. Below it, the text 'THDI Protection Settings' is displayed. A green bar indicates 'THDI Control Mode Active'. There are two adjustable fields: 'THDI Set (%)' with a value of 40 and 'Delay (sn.)' with a value of 20. Each field has up and down arrow icons. At the bottom, there are two buttons: 'TURN BACK' with a left-pointing arrow icon and 'OK' with a green checkmark icon.

In this page current harmonic control mode can be made active or passive, harmonic of current and delay can be set. When the setting is active color of the button's writing becomes green, when it is passive it becomes red. When the control mode is active and the total voltage harmonics get higher than the setted harmonic values, the device waits as much as delay; after the time of the delay comes to an end

it makes the compensation stop and "High Harmonic Current" warning comes to the screen. Also "ALR1" is on. When the control mode is passive, the device doesn't make voltage harmonic control.

Pressing the "Confirm" button, the saved data is recorded and returns to "Settings" page. When the "Return" button is pressed, without recording any value, turns to "Settings" page.

Settings 3.4 Generator Compensation Setting

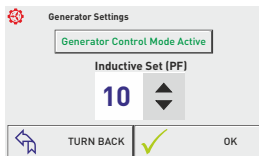

In this page generator control mode can be made passive or active and inductive/active can be set. When the setting is active color of the button's writing becomes green, when it is passive it becomes red. When the generator mode is activated, the device compensates according to the set "inductive set value" while the generator is on. When the generator mode is passive, compensation is stopped while the generator is on.

Pressing the "Confirm" button, the saved data is recorded and returns to "Settings" page. When the "Return" button is pressed, without recording any value, turns to "Settings" page.

Settings 3.5 Voltage Protection

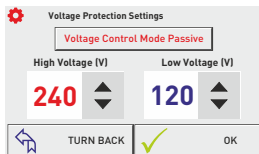

In this page Voltage control mode can be made passive or active, High voltage and low voltage values can be set. When the setting is active color of the button's writing becomes green, when it is passive it becomes red. When the voltage control mode is active, it stops the compensation if Set voltage get out of upper and lower limits. Then the display will show "High Voltage" or "Low Voltage" warning.

Also "ALR1" is on. When the Voltage Protection mode is passive, the device doesn't make voltage control.

Pressing the "Confirm" button, the saved data is recorded and returns to "Settings" page. When the "Return" button is pressed, without recording any value, turns to "Settings" page.

Settings 3.6 Inductive and Capacitive Alarm



In this page inductive/active and capacitive/active Alarm mode can be made passive or active and inductive/active and capacitive/active ratio can be set. When the setting is active color of the button's writing becomes green, when it is passive it becomes red. When the ratios rise above the activated set value, the display shows "High Inductive" or "High Capacitive" warning. Also "ALR1" is on. When the Alarm mode is passive, the display doesn't show warning.

Pressing the "Confirm" button, the saved data is recorded and returns to "Settings" page. When the "Return" button is pressed, without recording any value, turns to "Settings" page.

Settings 3.7 Compensation Target Setting

Enter the Target Ratios!

Set Value % Tolerance %

010 10

Cos: 0.9950 Inductive

TURN BACK OK

In this page, the inductive/active and capacitive/active ratio that the device is aiming at compensation can be set.

Pressing the "Confirm" button, the saved data is recorded and returns to "Settings" page. When the "Return" button is pressed, without recording any value, turns to "Settings" page.

Set: Set: Targeted compensation setpoint is entered here. Inductive or capacitive set can be entered. The Cosine value that will occur as a result of the entered set value appears at the bottom of the screen.

Tolerance: The contactor, capacitor and reactors in the steps are the inductive and capacitive directions of motion that will be given to the device in order to provide less intervention in order to extend their life. The device will not alter the current intervention for reactive power changes within the SET \pm Tolerance field in this field.

Ex.: If SET value is 0% (Cos: 1) and Tolerance value is 2%, the device will not change the current intervention for reactive power changes within this area after reaching Inductive 2% and Capacitive 2%.

Settings 3.8 Temperature Control

Temperature Protection Settings

Temperature Control Mode Active

High Temperature Low Temperature

30 -10

TURN BACK OK

In this page Temperature control mode can be made passive or active, High Temperature and low Temperature values can be set. When the setting is active color of the button's writing becomes green, when it is passive it becomes red. When the Temperature control mode is active if Set Temperature get out of upper and lower limits, the display will show "High Temperature" or "Low Temperature" warning. Also "ALR2" is on.

-20 °C Low Temperature Alert

40 °C High Temperature Alert

-20 °C Normal Temperature

Pressing the "Confirm" button, the saved data is recorded and returns to "Settings" page. When the "Return" button is pressed, without recording any value, turns to "Settings" page.

Settings 3.9 Modbus Settings

ModBus Settings - 8 N 1

Baudrate Modbus Address

19200 001

TURN BACK OK

In this page remote communication settings can be done to the device. Address of Baudrate and Modbus can be changed. Databits=8, Stoppbits=1 and Parity=none values are fixed.

Pressing the "Confirm" button, the saved data is recorded and returns to "Settings" page. When the "Return" button is pressed, without recording any value, turns to "Settings" page.

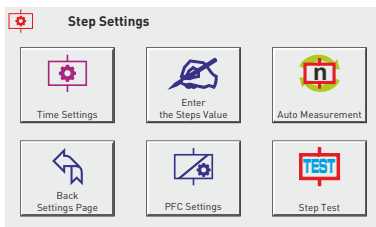

When the Stage Button is pressed, Stage Settings page comes to the screen in the dynamic area. Times related to steps, Enter Stage Value, Automatical Measurement, PFC Settings, Stage Test and Settings Page can be passed from this page.

3.10.1 Times: Drive, Discharge and Settling Times are set.

3.10.2 Enter Step Value: Value of step is entered manually

3.10.3 Automatical Measurement: The selected steps are measured.

Back Settings Page: Returns to the Settings page.

3.10.4 PFC Settings: Compensation can be active or passive mode.

3.10.5 Stage Test: The selected steps are checked.

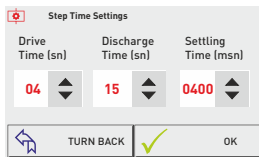

In this page, the intervention time, the capacitor discharge time and the capacitor settling time can be set.

Drive time: it is the Intervention (Step taking-drop) time of the device to the power change in the system.

Discharge time: It is the delay time of re-commissioning the same step after dropping the capacitor in the step.

Step settling time: When a few steps are needed is the delay time between steps.

Pressing the "Confirm" button, the saved data is recorded and returns to "Settings" page. When the "Return" button is pressed, without recording any value, turns to "Settings" page.

Settings Step Settings 3.10.2 Automatic Level Measurement

Select the Steps to Be Measured!

1	2	3	4	5	6	7
8	9	10	11	12	13	14
15	16	17	18	TCR	All Pass	All Active

TURN BACK START

In this page, step is measured automatically. Measurement could be done automatically only at chosen step. If you press the button of the step you desired, logo of the step will change. According to the Page 8th and 10th steps are chosen for the automatic measurement. After choosing the steps, automatic measurement starts when the "start" button is pressed.

Step Measurement 1. Step [kVar]

Step Test Was Started

L1	-01.50
L2	-01.50
L3	-01.50

CANCEL OK

When the "Return" button is pressed, without recording any value, turns to "Settings" page.

When the automatic step measurement is started, a page comes to the screen like on the side. In the page it could be seen which measurement of the step is done and phases of the measured value is shown separately.

If the condenser is connected to the step, (-) sign is seen on the left. If the shunt reactor is connected to the step, the value does not have a sign. The chosen steps will be measured subsequently and when the measurement is finished press "confirm" button in order to record values.

When the "cancel" button is pressed, measurement of the step is canceled and measured values returns to the automatic step measurement screen without recording.

Settings Step Settings 3.10.3 Step Test

Select the Steps to Test!

1	2	3	4	5	6	7
8	9	10	11	12	13	14
15	16	17	18	TCR		

TURN BACK SETTINGS

In this page step test is made manually. Control of the step's output (like connection etc.) can be done. Chosen steps are made active and the steps are on.

When the "Return" button is pressed, "step setting" page comes to the screen; when the Setting button is pressed "setting page comes.

Settings Step Settings 3.10.4 Entering the Manual Step Value

Enter the Step Value!

Step	Phase	Value [kVar]
01	L1	-01.00

1. Step L1 Value was Saved!

TURN BACK OK

In this page, manual step value can be entered. Mono and three phase capacitor or shunt reactor values can be entered.

Step, Phase and Values are set to help with the up and down arrow buttons. The values entered by pressing the "Confirm" button are saved and the writing comes to the related screen as "1. Stage L1 Value Registered!".

If the value to be entered is mono phase, select "L1, L2 or L3" from the phase section according to the phase to which it is connected. "L123" should be selected for the three phases.

Example: The value entered in the display is 1kvar capacitor in L1 phase and Step 1.

When the "Return" button is pressed, without recording any value, turns to "Settings" page.

Settings Step Settings 3.10.5 Entering the Manual SVC Value

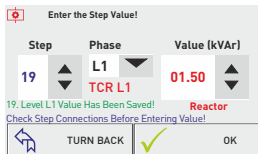

Enter the Step Value!

Step	Phase	Value (kVAr)
19	L1 TCR L1	01.50

19. Level L1 Value Has Been Saved!
Check Step Connections Before Entering Value!

TURN BACK OK

In this page, manual step value can be entered. Mono and three phase capacitor or shunt reactor values can be entered.

In order to enter the values of shunt reactors connected to TCR, steps 19 [shunt reactor connected to T1], 20 [shunt reactor connected to T2] and 21 [shunt reactor connected to T3] are used.

The values of the shunt reactors connected to the T1, T2 and T3 outputs of the driver must be entered in the 19th, 20th and 21st steps respectively.

Example: With the value entered on the screen, a 1.5kVAr shunt reactor has been added to the T1 output of the driver.

When the "Return" button is clicked, it returns to the "Settings" page without saving any value.

Settings Step Settings 3.10.6 PFC Setting

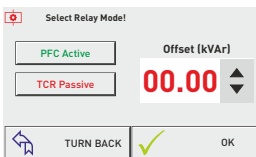

Select Relay Mode!

<input checked="" type="checkbox"/> PFC Active	Offset (kVAr) 00.00
<input type="checkbox"/> TCR Passive	

TURN BACK OK

In this page, PFC (compensation) and TCR (SVC) feature can be activated or deactivated. The offset value can be adjusted.

PFC (compensation) can be disabled in necessary cases (such as manual use). When the PFC is disabled, the device stops interfering with the system. In this case, the device only measures.

PFC: Active/passive the intervention of the device with capacitors and shunt reactors connected to the reactive powers in the system. When the PFC is passive, the device will not drive a step. When the device is energized again, if there is a capacitor or shunt reactor connected to the step, PFC function it will be activated automatically.

TCR: TCR: Activates / passives the intervention of the device to the reactive powers in the system with the driver (if there is a driver in the system). While the TCR is passive, the device will not drive shunt reactors.

Offset: It is used for reactive powers seen by the meter but not seen by the reactive relay. This value, which the device does not see, is calculated software and intervened accordingly.

Ex.: If the offset is entered as -10kVAr, it means that the reactive relay does not see a three-phase capacitive power of 10kVAr. The reactive relay will interfere with this power with a three-phase 10kVAr inductive power in addition to the target cosine value.

The values entered are saved by clicking the "OK" button. When the "Return" button is clicked, it returns to the "Step Settings" page without saving any value.

Settings 3.11 Device Settings

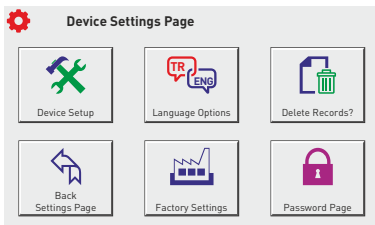

Device Settings Page

 Device Setup	 Language Options	 Delete Records?
 Back Settings Page	 Factory Settings	 Password Page

When the Device Setting button is pressed, Device Setting page comes to the dynamic screen. You can pass Device Setup, Language Choice, Deleting the Recordings, Factory Settings, Password Menu and Settings from this page.

3.11.1 Device Setup: Current Transformer Test and Automatic Step Measurement Operation

3.11.2 Language Options : Language settings of the device are changed.

3.11.3 Delete the Recordings : Data which are taken automatically by the device are deleted.

Back Setting Page : Returns to the settings page

3.11.4 Factory Settings: Factory or Menu settings, assumed values are returned.

3.11.5 Password Page: Password protection is assigned to the device.

Settings Step Settings **3.11.1 Device Setup**

Enter the CT Ratio

0150 /5A

TURN BACK OK

Current Transformer Test Current

CT Test was Started

L1 380.0 A

L2 380.0 A

L3 380.0 A

Cancel CT Test Confirm CT Connection

Step Measurement 1. Step (kVar)

Step Test Was Started

L1 -01.50

L2 -01.50

L3 -01.50

CANCEL OK

In order to set the device press the "up" and "down" buttons, enter the current transformer value. When you press "confirm" button the device starts current transformer test automatically; after completing the test if any matter is available; the device gives warning with connections.

If there is no matter in the connections, after completing the current transformer test; the device start the step measurement automatically. When the device measured all of the steps, if the "confirm" button is pressed, all of the steps are recorded. When the "cancel" button is pressed; the device cancels the step measurements and returns to "Automatic Measurement" screen without recording the step measurements. After completing the step measurement; the device starts to compensation according to the recorded values.

Settings Step Settings **3.11.2 Language Options**

Language Selection

Back Settings Page

TURKICE

ENGLISH

In this menu, The language settings of the device are changed as Turkish or English. When you click to the language you desired, the language of the device changes and turns to device setup page.

When the "Back" button is pressed, "Device Setup" page comes to the screen.

Settings Step Settings **3.11.3 Password Settings**

Password Menu Enter New Password!

Password Control Passive 2580

1 2 3 Del

4 5 6 0 Cancel

7 8 9 OK

In this page control of the password becomes active, the device can be protected against the unauthorized intervention. After the control of the password is made active ;entered password value is recorded. the password consist of 4 letters. You can enter the password pressing the numbers. When the password is entered, press "confirm" button to record password. When you quit from the setting menu; the device is protected anymore.

When the "Return" button is pressed, it turns to the "Setting" page without doing operation.

Settings ← Step Settings ← 3.11.4 Delete The Recording

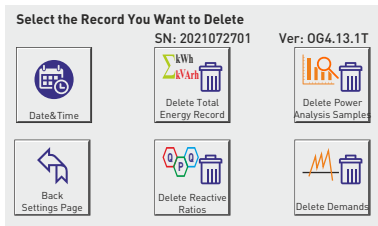

When the Record Delete button is pressed, the Record Delete page appears on the screen in the dynamic area. In this page, the total energy values, power analysis samples, Ratios and Demand values automatically received by the device are deleted and Date/Time information can be changed. Includes the serial number and software version of the device.

Date&Time: You can change the date and time information on the device from this screen.

Delete Total Energy Values:Deletes total energy values (Active, Inductive, Capacitive).

Delete Power Analysis Samples: Deletes the sample records of the power analysis.

Back Settings Page: Returns to the Settings page without performing any operation.

Delete Ratios: Deletes Capacitive/Active and Inductive/Active ratios.

Delete Demands: Deletes Active Power, Reactive Power, Apparent Power and Current Demand.

Press the record button you want to delete. Then the confirmation message box will come up again. If you press the "confirm" button here, the record will be deleted. If you press the "cancel" button. It returns without deleting the records.

When you press the "Back Settings Page" button, the main page of the device setup is displayed.

Settings ← Device Settings ← 3.11.5 Date and Time Settings

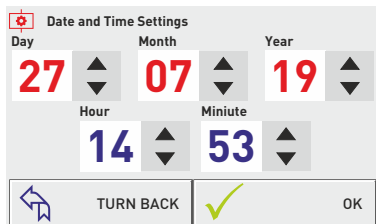

When the date and time button is pressed, the Date and Time settings page appears in the dynamic area. On this page, date and time settings of the device can be changed and saved.

The values entered are saved by clicking the "OK" button. When the "Return" button is clicked, it returns to the "Delete Record" page without saving any value.

Settings ← Step Settings ← 3.11.6 Factory Settings

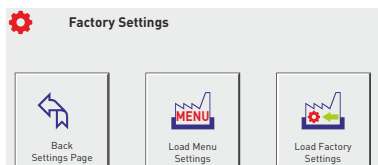

When the Factory Setting button is pressed, factory settings main page comes to the dynamic screen. In this page all values of the device are expected to return factory settings or only menu values can be provided to return factory values.

Note: Returning to the factory settings necessitates the device to be set up again. (Current transformer value, step value, menu settings etc. All values and records will be reset.)

Note: Returning to the menu settings does not require the device to be reinstalled.
 (Harmonic Voltage, Harmonic Current, Step Times, Generator, Voltage Min / Max, Alarm, Compensation Target Values, Temperature and Modbus Settings will be reset.)

Press the button you want to return to the old settings. Then the confirmation message box will come up again. If you press the "confirm" button on this page, the relevant settings will return to the old factory values. If you press the "cancel" button, it exits without doing anything.

When you press the "Back Settings Page" button, the main page of the device setup is displayed.

How to Choose a Main Page?

The home page is the page that will appear on the dynamic display when the device is energized and will remain visible without pushing the buttons. You can define the main page you want to see continuously from the following measurement pages.

After pressing the measurements button to select it as the home page, **Measurements Page 1** is displayed on the dynamic screen. If the measurements you want to select are in **Measurements Page 2**, press the Measurements Page 2 button. Then press the button of the measurements you want. The measurements you selected are displayed on the dynamic screen. If there is no transition to another page for 16 minutes, it will be defined as the home page.

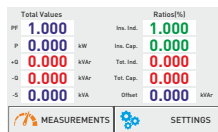

Measurement Page-1
Total Values

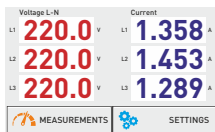

Measurement Page-1
Voltage & Current

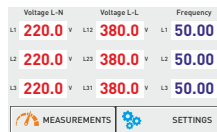

Measurement Page-2
Voltage & Frequency

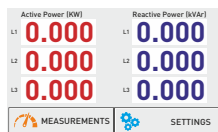

Measurement Page-1
Instant Powers

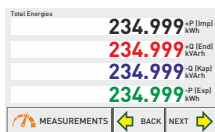

Measurement Page-1
Total Energy Values

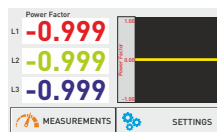

Measurement Page-2
Power Factor

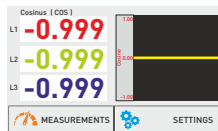

Measurement Page-1
Cosinus

How to Install the Device?

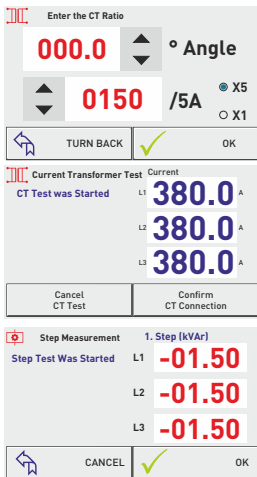

To access the device setup page, enter the following menu, respectively;

Settings → **Device Settings** → **Device Setup**

After reaching the device setup page, the current transformer value input (primary) and output (secondary) values are entered by pressing the up or down buttons. (If the current transformer value is 150/5A, 150 value is entered as on the screen.) When the "Confirm" button is pressed, the device automatically switches to current transformer starts the test.

Current Transformer Test: The device activate the first 3 steps one by one and then de-activate them one after the other. The device repeats this 2 times.

In ROG-MT18 SVC; For the current transformer test, connect three phase capacitors in 1/40 (*) of the accrual rate (**) value to the first three stages (C1, C2, C3) of the device. [* : The total value of the first three levels.] [** : Voltage Transformer Ratio x Current Transformer Ratio] (For example. Let the current transformer value be 50/5A. Let the voltage transformer ratio be 34500/400V. CTR = 10 and VTR = 86.25, Accrual Multiplier 862.5. Three-phase capacitor value should be = $862.5 / 40 = 22\text{kVAr}$.)

In RGT-MT18 SVC; For the current transformer test, connect three phase capacitors in 1/40 (*) of the current transformer value to the first three stages (C1, C2, C3) of the device. [* : The total value of the first three levels.]

After the current transformer test is completed, if there is any problem in the connections, the device will give a warning and will not accept the connection. After correcting the connection errors according to the warnings, you can start the device setup again. After the current transformer test is learned properly (k-l terminals should write true/reverse), if you press the "I confirm the connection" button (if the k-l terminals are written reverse, the device will automatically correct the connection), the device will automatically start the step measurement. After the device measures all the steps (it says "Step measurement finished"), when the "Confirm" button is pressed, all measured steps are saved and the device starts to intervene.

When the "Cancel" button is pressed, it will cancel and returns to the "Automatic measurement" screen without saving the step measurements.

How to Change the Current Transformer Value?

To reach the current transformer value change page, enter the following commands respectively;

Settings → **Current Transformer** → **Change Current Transformer Ratio**

After reaching the Change current transformer page (Figure 1), press the up and down buttons to enter the current transformer value. When the "Confirm" button is pressed, the device automatically starts the current transformer test (figure 2) if there is any trouble in the connections after the current transformer test is finished, the device will show the warning and will not accept the connection. After correcting the connection errors according to the warning, you can start the current transformer test again.

If there is no problem with the connections, the device will automatically start to measure the Step after the current transformer test is confirmed (figure 3). After the device has measured all the steps, pressing the "Confirm" button saves all measured steps and the device starts to intervene.

When the "Cancel" button is pressed, it will cancel and returns to the "Automatic measurement" screen without saving the step measurements.

How is the Current Transformer Test Done ?

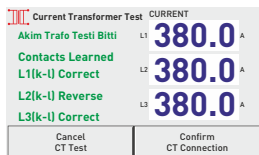
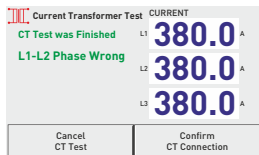
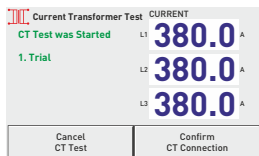

In order to reach current transformer test page, enter these menus subsequently;

Settings **Current Transformer** **Start CT Test**

The test starts automatically when the start current transformer test button is pressed.

Current Transformer Test: The device activate the first 3 steps one by one and then de-activate them one after the other. The device repeats this 2 times.

In ROG-MT18 SVC; For the current transformer test, connect three phase capacitors in 1/40 (*) of the accrual rate (**) value to the first three stages (C1, C2, C3) of the device. [* : The total value of the first three levels.] [**: Voltage Transformer Ratio x Current Transformer Ratio](See page 19 for an example.)

In RGT-MT18 SVC; For the current transformer test, connect three phase capacitors in 1/40 (*) of the current transformer value to the first three stages (C1, C2, C3) of the device. [* : The total value of the first three levels.]

If there is a phase error warning after 3 attempts (the voltage and current sequence of those phases are incorrect if they are read.) After switching off the power, relocate or disconnect the relevant phases from the voltage terminal. After this process is completed, the current transformer test must be restarted. After correcting the connections and starting the current transformer test again, the device will have learned the terminals at the third attempt. The device indicates that the k-l ends of each phase are connected correctly or reverse. If you press the Confirm connection button, the device will terminate the current transformer test by correcting the reverse ends software if there is a k-l terminal with reverse connection.

How is the Step Measurement Done?

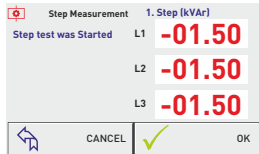

In order to reach step measurement (automatic measurement) page, enter these menus subsequently;

Settings **Step Settings** **Auto Measurement**

In order to choose the steps which is to be measured in the automatic measurement page; press the button of the step.

When the button is pressed; logo of the step is changed.

After choosing the steps, when the "Start" button is pressed; automatic measurement starts.

When the step measurement starts, step measurement page comes to the screen. The page shows which measurement of the step is done and the value that is measured at each phase. If the capacitor is connected, (-) sign appears on the left. If the shunt reactor is connected, there is no sign of the value. After the measurement of the

step is completed, subsequent step measurement starts if there is chosen steps. When the measurements completed "step test is completed" sign comes to the screen. Press the "confirm" button in order to record values. When you press the "confirm" button; "step measurement is confirmed" sign comes to the screen and turns to the main page and the device start to interfere.

If you press the "return" button, main page of the step comes to the screen without doing any operation.

How is the Step Value Entered Manually?

In order to reach "Enter Step Value" page, enter these menus subsequently;

Settings → **Step Settings** → **Enter the Steps Value**

After reaching the Enter Step Value page; Step, Phase, and Values are set pressing "up" and "down" buttons. Then the values are recorded pressing the "Confirm" button and "1. Step L1 Value was Saved!" sign comes to the screen.

Step	Phase	Value (kVar)
01	L1	-1.00

1. Step L1 Value was Saved!

TURN BACK OK

Ex: Capacitor value is entered to the 1st step at the L1 phase

If the value to be entered is mono phase, from the phases section "L1,L2 or L3" should be chosen according to the phase which is connected to; if it is three phase "L123" should be chosen.

Note: If the capacitor will be added to the system, the value to be entered should be "-" (picture6); if the shunt reactor is to be added, the value to be entered should be "+" (picture7).

According to the entered value, the words "Capacitor" or "Reactor" will appear on the screen.

Step	Phase	Value (kVar)
02	L123	-10.00

Capacitor

TURN BACK OK

3 phase 10kVar capacitor value entered to the 2nd step.

Step	Phase	Value (kVar)
03	L3	+1.50

Reactor

TURN BACK OK

1.5kVar shunt reactor value entered to the 3rd step at the L3 phase.

How is the SVC Value Entered Manually?

In this page, manual step value can be entered. Mono and three phase capacitor or shunt reactor values can be entered.

In order to enter the values of shunt reactors connected to TCR, steps 19 (shunt reactor connected to T1), 20 (shunt reactor connected to T2) and 21 (shunt reactor connected to T3) are used.

Step	Phase	Value (kVar)
19	L1	01.50

19. Level L1 Value Has Been Saved!
Check Step Connections Before Entering Value!

Reactor

TURN BACK OK

The values of the shunt reactors connected to the T1, T2 and T3 outputs of the driver must be entered in the 19th, 20th and 21st steps respectively.

Example: With the value entered on the screen, a 1.5kVar shunt reactor has been added to the T1 output of the driver.

When the "Return" button is clicked, it returns to the "Settings" page without saving any value.

How is The Step Test Done?

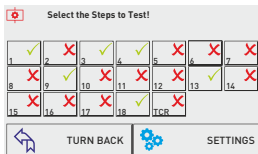

In order to reach the step test page ,enter these menus subsequently;

Settings → **Step Settings** → **Step Test**

All of the steps will be apparent on the screen; after reaching Step Test Page. Touching the step; it is pulled and left back. If the logo of the step is ✗ "red x" ; when Quit the Step button is pressed, logo of the step becomes ✓ green thick and gives Quit. When we press the same step button again, the logo changes and the steps don't give quit.

If "the Return" button is pressed; step main page comes to the screen by abandoning steps one by one.

How to Return to Factory Settings?

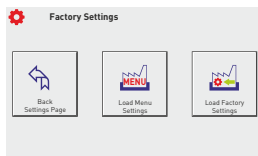

In order to return Factory Settings page, enter these menus subsequently;

Settings → **Device Settings** → **Factory Settings**

After reaching the Factory Settings page when "Load Factory Settings" button is pressed; "Load Factory Settings?" message box come to the screen and when the "Accept" button is pressed; the device returns to Factory Settings.

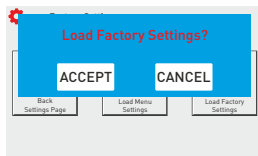

When the "Cancel" button is pressed on the message box, it returns to Factory Setting page without doing operation.

Note: Restoring the factory settings requires reinstallation! (Current transformer value, step values, menu settings, etc. all values and records will be reset.)

How to Return to Menu Settings?

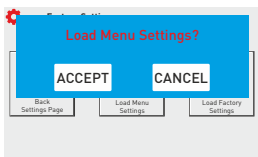

In order to return Factory Settings page,enter these menus subsequently;

Settings → **Device Settings** → **Factory Settings**

After reaching the Factory Settings page when "Load Menu Settings" button is pressed; "Load Menu Settings?" Message box come to the screen and when the "Accept" button is pressed; the device returns to Menu Settings.

When the "Cancel" button is pressed on the message box, it returns to Load Factory Setting page without doing operation.

Note: Return to the Menu settings requires reinstallation! (Harmonic Voltage, Harmonic Current, Step Times, Generator, Voltage Min / Max, Alarm, Compensation Target Values, Temperature and Modbus Settings will be reset.)

Medium Voltage Three-phase (3P4W) Connection Scheme

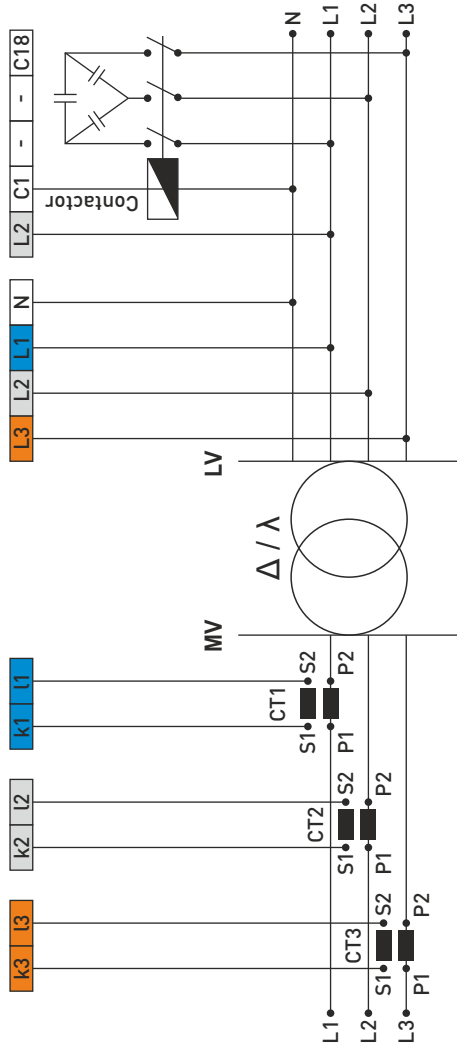

Low Voltage Three-phase (3P4W) Connection Scheme

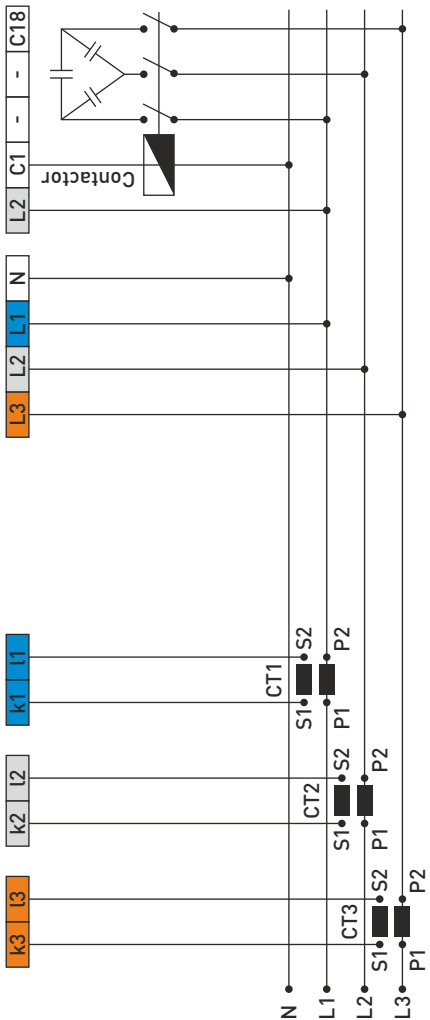

Low Voltage Mono-phase (1P2W) Connection Scheme

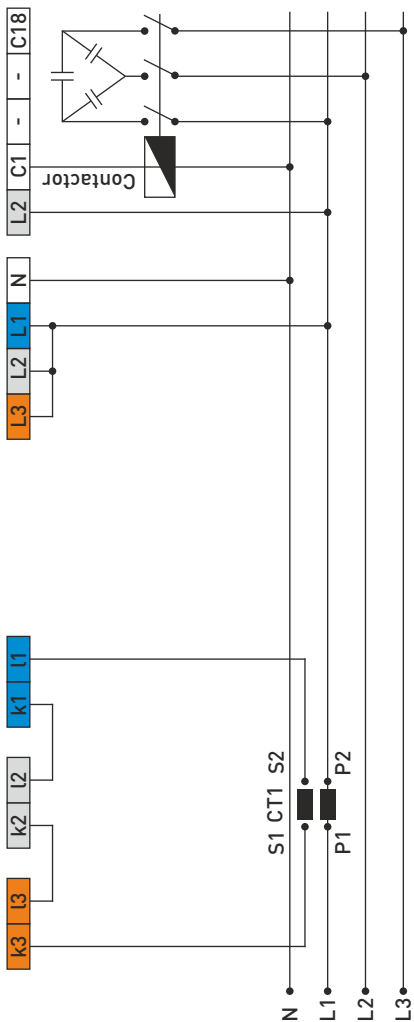

Connecting PFC and Inductive Load Driver (SVC)

NOTE : If the wiring distance between PFC and Inductive Load Driver does not exceed 5 meters, GND connection is not required.

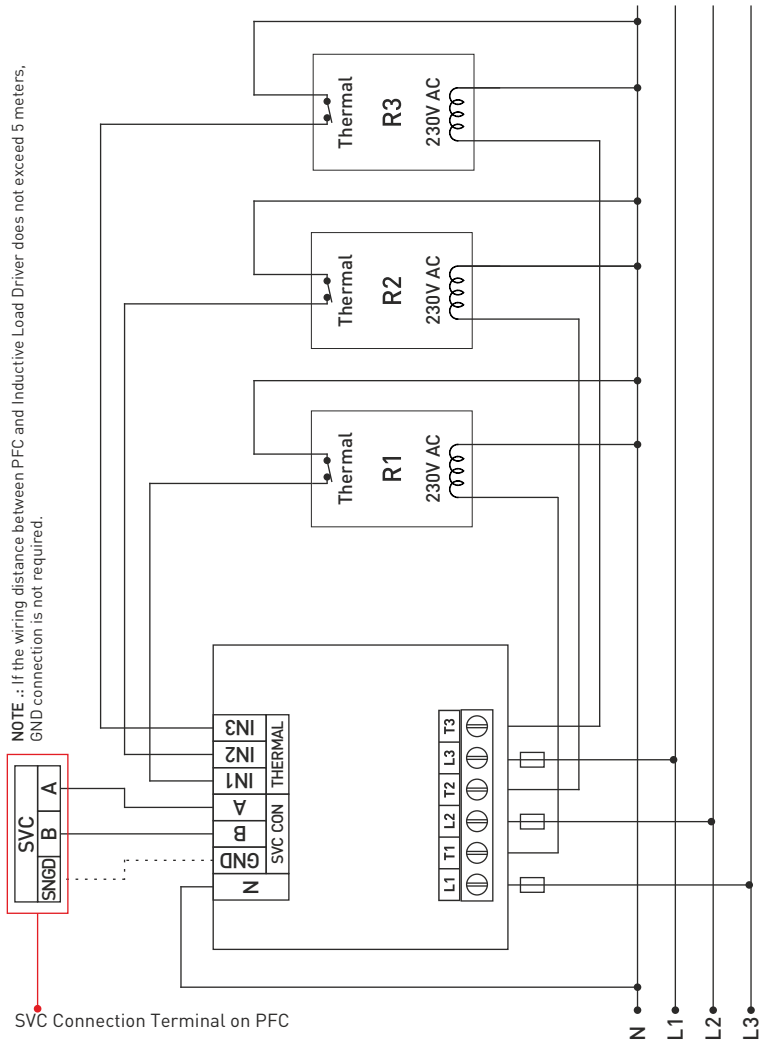

SVC Connection Terminal on PFC

Remote Communication with RS485 (GSM-MOD)

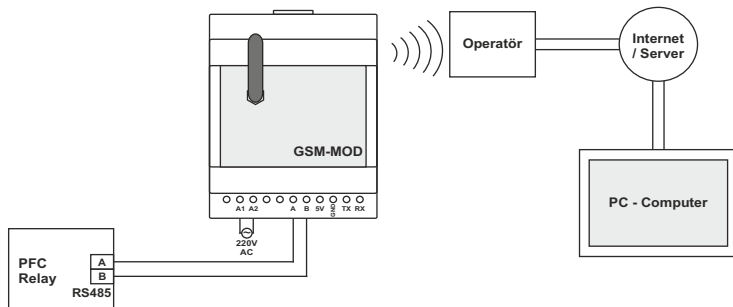

Only reactive relay or together with counter and energy analyzer can be connected with GSM-MOD on remote communication. Using a 100MB (recommended) data line from GSM operators, remote communication is made with reactive relay via www.tenseenerji.com (server).

Remote Communication with RS485 (ETH-MOD)

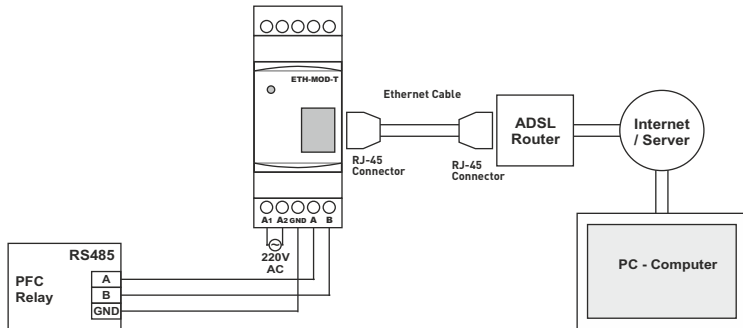

Only reactive relay or together with counter and energy analyzer can be connected with GSM-MOD on remote communication. Remote connection is made with reactive relay via www.tenseenerji.com (server) by connecting modem.

Capacitor Account Table according to Connection Type

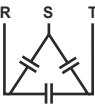
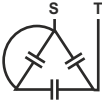
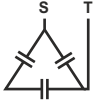
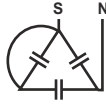
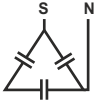
					
Capacitor Power	3 Phase Connection (Q/3)	2 Phase Connection Bridge (Q/3)	2 Phase Connection (Q/4)	Phase-Neutral Bridging Connection (2xQ/9)	Phase-Neutral Connection (Q/6)
0,5 KVAR	0,16 KVAR	0,16 KVAR	0,12 KVAR	0,11 KVAR	0,08 KVAR
1 KVAR	0,33 KVAR	0,33 KVAR	0,25 KVAR	0,22 KVAR	0,16 KVAR
1,5 KVAR	0,5 KVAR	0,5 KVAR	0,37 KVAR	0,33 KVAR	0,25 KVAR
2,5 KVAR	0,83 KVAR	0,83 KVAR	0,62 KVAR	0,55 KVAR	0,41 KVAR
5 KVAR	1,66 KVAR	1,66 KVAR	1,25 KVAR	1,11 KVAR	0,83 KVAR
7,5 KVAR	2,5 KVAR	2,5 KVAR	1,87 KVAR	1,66 KVAR	1,25 KVAR
10 KVAR	3,33 KVAR	3,33 KVAR	2,5 KVAR	2,22 KVAR	1,66 KVAR
15 KVAR	5 KVAR	5 KVAR	3,75 KVAR	3,33 KVAR	2,5 KVAR
20 KVAR	6,66 KVAR	6,66 KVAR	5 KVAR	4,44 KVAR	3,33 KVAR
25 KVAR	8,33 KVAR	8,33 KVAR	6,25 KVAR	5,55 KVAR	4,16 KVAR
30 KVAR	10 KVAR	10 KVAR	7,5 KVAR	6,66 KVAR	5 KVAR

Step Creation According to Power Analysis Examples?

Table1					Table2			
	L1	L2	L3	Time (min.)	Threephase Capacitor (kvar)	Monophase [L1] Capacitor (kvar)	Monophase [L2] Capacitor (kvar)	Monophase [L3] Capacitor (kvar)
1.Sample	0.00	0.00	1.50	571	-	-	-	1.50
2.Sample	0.00	1.00	1.50	525	-	-	1.00	1.50
3.Sample	2.00	1.50	0.50	490	1.50	1.50	1.00	-
4.Sample	0.75	1.00	1.50	470	2.50	-	0.20	0.70
5.Sample	1.50	1.80	1.00	453	3.00	0.50	0.80	-
6.Sample	0.50	2.00	2.50	400	1.50	-	1.50	2.00
7.Sample	0.20	1.50	1.90	385	0.50	-	1.30	1.70
8.Sample	0.80	0.00	0.50	350	-	0.80	-	0.50
9.Sample	0.30	0.40	0.35	300	1.00	-	0.05	-
10.Sample	2.40	3.50	4.50	295	7.50	-	1.00	2.00
11.Sample	3.20	4.00	1.50	280	5.00	1.60	2.30	-
12.Sample	2.50	4.50	1.90	257	6.00	0.50	2.5	-
13.Sample	2.70	2.90	3.20	236	8.00	-	0.20	0.40
14.Sample	0.50	1.00	1.50	205	1.50	-	0.50	1.00
15.Sample	0.00	-0.10	0.50	192	-	-	-	0.50
16.Sample	0.35	1.00	1.70	180	1.00	-	0.65	1.35
17.Sample	2.50	0.50	1.50	120	1.50	2.00	-	1.00
18.Sample	3.20	4.70	5.50	100	10.0	-	1.30	2.10
19.Sample	3.00	4.20	2.50	70	7.50	0.50	1.70	-
20.Sample	2.70	0.50	1.50	45	1.50	2.20	-	1.00

In the Table 1; artificial samples are created. In Table 2 ; three phase and one phase samples which can be used through these samples are created. While step structures are being created; the interval values should be interfered. Replace highest three phase capacitor values to the first steps.

Lowest 0.5 kvar and highest 10 kvar are available in three phase capacitors. **0.5kvar, 1kvar, 2.5kvar, 5kvar, 7.5kvar** three phase capacitor can be used.

Lowest 0.5kvar and highest 2.2kvar are available at one phase capacitors to be used at L1 phase. **0.5kvar, 1kvar and 1.5kvar** one phase capacitor can be used.

Lowest 0.20kvar and highest 2.3 kvar are available at one phase capacitors to be used at L2 phase. **0.25kvar, 0.5kvar, 1kvar and 1.5kvar** one phase capacitor can be used.

Lowest 0.40kvar and highest 2.1 kvar are available at one phase capacitors to be used at L3 phase. **0.25kvar, 0.5kvar, 1kvar, and 1.5kvar** one phase capacitor can be used.

Dimensions

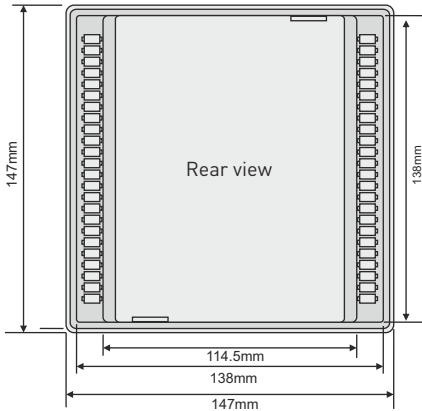
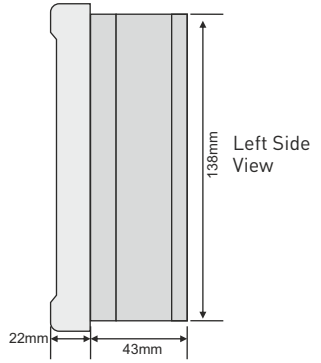
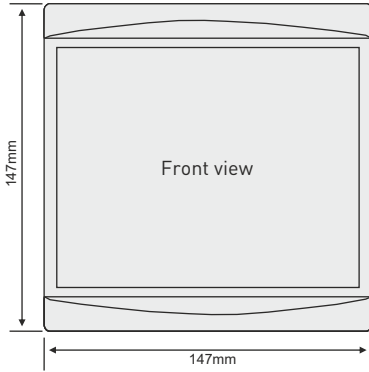

Screwed side ear (apparatus)

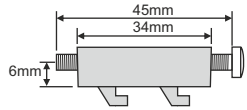

Side ear (apparatus)



Factory Defaults

Setting Name	Factory Value	Minimum Value	Maximum Value	Unit
Current Transformer Ratio	5/5	5/5	5000/5	A
Harmonic Voltage (A/P) <i>Passive</i>	10	5	99	%
Harmonic Voltage Delay	30	1	60	sec.
Harmonic Current (A/P) <i>Passive</i>	50	5	99	%
Harmonic Current Delay	50	1	60	sec.
High Voltage (A/P) <i>Passive</i>	250	240	285	V
Low Voltage (A/P) <i>Passive</i>	180	120	200	V
Inductive Alarm (A/P) <i>Passive</i>	20	5	50	%
Capacitive Alarm (A/P) <i>Passive</i>	15	5	50	%
Generator (A/P) <i>Passive</i>	45	1	50	%
Inductive Set	5	1	50	%
Capacitive Set	10	1	50	%
High Temperature (A/P) <i>Passive</i>	50	30	70	°C
Low Temperature (A/P) <i>Passive</i>	-10	-20	10	°C
Drive Time	2	1	15	sec.
Discharge Time	15	1	99	sec.
Settling Time	400	100	2000	msec.
Baudrate	9600	2400	115200	bps.
Modbus Address	1	1	247	
Step Counter	16	1	18	

Fixed Values: Parity: none, Stopbits:1, Demand Time: 15min.

(A/P): Can be active or passive.

Technical Features

Operating Voltage	100V - 300V AC
Operating Frequency	50 / 60 Hz
Operating Power	<12VA
Operating Temperature	-20°C.....+55°C
Voltage Measuring Range	5V -280V AC
Current Measurement Range	5mA - 5,5A
Current Transformer Ratio	5/5A.....5000/5A, 5/1A.....5000/1A
Voltage, Current Accuracy	%±0,5
Active Accuracy	%±1
Reactive Accuracy	%±2
Real Time Clock	>5 years
Harmonic Voltage	2 - 61
Harmonic Current	2 - 61
Remote Connection Speed	2400, 4800, 9600, 19200, 38400, 57600, 115200bps
Remote Connection Features	Databits.:8, Stopbits.:1, Parity:None
Remote Link Interface	RS485 MODBUS RTU
Indicator	5" resistive touch color LCD
Connection Type	Plug-in terminal connection
Contact	3A / 250V AC Resistive Load
Number of Steps	18 + TCR
Cable Diameter	1.5mm ² , 2.5mm ² (voltage inputs)
Weight	<900Gr.
Mounting	Mounting on the front of the panel
Operation Altitude	<2000meters
Protection Class	IP41 (Front Panel), IP20 (Body)
Panel Hole Dimensions	140mm x 140mm

Contact Informations

Web: www.tense.com.tr

Mail: info@tense.com.tr

Muratpaşa Mah. Uluyol Cad.

İşkent Sanayi Sitesi. E Blok, 1.Kat

BAYRAMPAŞA / İSTANBUL / TÜRKİYE

Tel: +90212 578 04 38 - 48 Fax: +90212 578 04 36



QUALITY SOLUTIONS

MADE IN TÜRKİYE  

